

LAGUNA TOOLS

LAGUNA

Laguna Tools-Fusion 3
(36" & 52") Table Saws

Model #MTSF3362203-0130-36

Model #MTSF3362203-0130-52

Owner's Manual-

**Warranty, Safety,
Specifications, Set-Up,
Set-Up Help Sections ,
Maintenance & Troubleshooting,
Wiring , Parts, Warranty and Return
Policy/Procedures.**



MTSF3362203-0130-36

MTSF3362203-0130-52

**KEEP THIS MANUAL WITH THE
MACHINE REFER TO OFTEN
USE IT TO INSTRUCT OTHERS**



© 2021, Laguna Tools, Inc. LAGUNA® and the LAGUNA Logo® are the registered trademarks of Laguna Tools, Inc. All rights reserved.

Laguna Tools: 744 Refuge Way
Grand Prairie, TX U.S.A. Service: +1 (800) 234-1976
or email: customerservice@lagunatools.com
Swift Series CNC Machines © 2021 Laguna Tools
12/01/2021



Table of Contents-

Warranty- Pg.5-7.
Shipping Damage- Pg. 8.
Safety Guidelines- Pg.9-19.
Grounding Instructions- Pg.20-21.
Safety Protocols (In-French)- Pg.22-27.
Inventory List- Pg.28.
Fusion 3 Table Saw Packaging- Pg.29.
Loose Parts Inventory- Pg.30.-31.
Hardware Inventory- Pg. 32-33.
Accessory Hardware & Tools- Pg. 34.
Set-Up Machine- Pg.35.
Unboxing Machine- Pg. 36-39.
Assembly- Pg.40-65.
SOP Preset Trunnion Bolts- Pg. 66-67.
DRO (Digital Read-Out) Calibration- Pg. 66-68.
DRO (Digital Read-Out) Trouble Shooting- Pg.70.
Maintenance & Trouble Shooting- Pg. 71-72.
Specifications- Pg.73-77.
Wiring Diagram- Pg. 78.
Replacement Parts- Pg. 79-83.
Replacement Parts table- Pg. 84-91.
Warranties- Pg. 92-99.

Laguna takes pride in our products and stands behind them with continuing service and support for our customers. Your Laguna machine was designed to bring a new dimension of productivity to your shop.

Before using your machine for the first time, learn how to use it. This manual covers a step-by-step process of assembly and machine operation. If you have any questions, this manual will provide answers.

We do our best to thoroughly document every product that we sell for customer reference. Several files are compiled to cover all components of a machine. Several machines may be covered by one manual. Many machines sold by Laguna include components with independent owners' manuals.

lagunatools.com

lagunatools.ca

lagunatools.eu

supermaxtools.com

lagunacleanair.com

lagunalathe.com

The information contained in this publication was correct at the time of print. In the interest of continuous innovation, we reserve the right to change specifications, design or included equipment without notice or obligation. No part of this publication may be reproduced, transmitted, or translated into any language in any form by any means without our written permission. Errors and omissions may be current.

Laguna Tools, Inc. LAGUNA® and the LAGUNA Logo® are the registered trademarks of Laguna Tools, Inc. All rights reserved. 10/14/2021.

LAGUNA

744 Refuge Way, Grand Prairie, TX 75050 U.S.A.

Service: +1 (800) 234-1976

Service: customerservice@lagunatools.com

lagunatools.com

Warranty-

This machine is covered by a warranty and the purchasing dealer can answer any questions you may have. Additionally, we will always be here to offer support, service information, and product supplies and services.

Laguna Tools® Customer Service

744 Refuge Way,

Grand Prairie, Texas, USA

8AM ET to 5PM PST Monday through Friday

LagunaTools.com

Service: +1 (800) 234-1976

customerservice@lagunatools.com

Every product sold is warranted to be free of manufacturers' defective workmanship, parts, and materials. For any questions about this product, the intended use or what it was designed for, customer service, or replacement parts – please reach out to our customer service department.

Registration-

To prevent voiding this warranty, all products sold must be registered within thirty (30) days of receiving. Registering the product will enable the original purchaser to receive notifications about important product changes and receive customer support.

<https://lagunatools.com/policies/warranty/>

Who Is Covered?

The applicable warranty covers only the initial purchaser of the product from the receipt date. The original purchaser must present the original receipt as proof of purchase.

What Is Covered?

Any part, determined by Laguna Tools®, to have a defect will be repaired or replaced (and shipped), without charge. It is required that the defective item/part be returned to Laguna Tools® with the complaint and proof of purchase in the original packaging that it was received. In the event the item/part is determined to be void of this warranty, the customer will be responsible for the cost to replace the item/part and all related shipping charges.

Warranty Limitations-

This limited warranty does not apply to natural disasters, acts of terrorism, normal wear and tear, product failure due to lack of maintenance or cleaning, damage caused by accident, neglect, or lack-of/inadequate dust collection. The warranty may be voided against proof of misuse/abuse, damage caused where repair or alterations have been made or attempted by others, using the product for purposes other than those described as intended use (unless with consent by Laguna Tools®), modification to the product, or use with an accessory that was not designed for the product. It is the responsibility of the user to understand basic woodworking machinery settings and procedures and to properly maintain the equipment in accordance with the standards provided in this manual.

Length of Warranty-

2 Year – New purchases through authorized dealers.

1 Year – New purchases directly from Laguna Tools.

1 Year – Blades and Accessories

Aside from being free of defects upon receiving, consumable parts, like cutters and abrasives, are not covered by this warranty unless otherwise stated by Laguna Tools®. These parts are designed to be used at the expense of the operator and are available for replacement or inventory purchase.

Shipping Damage-

Laguna Tools® and the purchasing customer is not responsible for damage or loss caused by a freight company or other circumstances not in the direct control of Laguna Tools®. All shipping related claims for loss or damaged goods must be made to Laguna Tools within twenty-four hours of delivery.

Safety-

Read and understand all warnings and operation instructions before using any tool or equipment. Always follow basic safety precautions to reduce the risk of personal injury. Improper operation, maintenance or modification of tools or equipment could result in serious injury and property damage. There are certain applications for which tools and equipment are designed. This product **should NOT be modified** and/or used for any application other than for which it was designed. It is important for you to read and understand this manual. The information it contains relates to protecting your safety and preventing problems.

Safety Guidelines – Definitions:

This manual contains information that is important for you to know and understand. This information relates to protecting your safety and preventing equipment problems. To help you recognize this information, we use the symbols below. Please read the manual and pay attention to these sections.

- ⚠ DANGER!** • An imminently hazardous situation which, if not avoided, will result in death or serious injury.
- ⚠ WARNING!** • A potentially hazardous situation which, if not avoided, could result in death or serious injury.
- ⚠ CAUTION!** • A potentially hazardous situation which, if not avoided, may result in minor or moderate injury.
- 🔧 TECH TIP** • A helpful tip from our technical staff.

⚠ WARNING! Important Safety Instructions-

Read and understand all warnings and operating instructions before using this equipment. Failure to follow all instructions listed below, may result in electric shock, fire, and/or serious personal injury or property damage. Woodworking can be dangerous if safe and proper operating procedures are not followed. As with all machinery, there are certain hazards involved with the operation of the product. Using the machine with respect and caution will considerably lessen the possibility of personal injury. However, if normal safety precautions are overlooked or ignored,

⚠ WARNING! Important Safety Instructions (Cont'd.)-

personal injury to the operator may result. Safety equipment such as guards, push sticks, hold-downs, feather boards, goggles, dust masks and hearing protection can reduce your potential for injury. But even the best guard won't make up for poor judgment, carelessness, or inattention. Always use common sense and exercise caution in the workshop. If a procedure feels dangerous, don't try it. Figure out an alternative procedure that feels safer. **REMEMBER: Your personal safety is your responsibility.**

This machine was designed for certain applications only. We strongly recommend that this machine not be modified and/or used for any application other than that for which it was designed. If you have any questions relative to a particular application, do not use the machine until you have first contacted the manufacturer to determine if it can or should be performed on the product.

If you have any questions relative to its application do not use the product until you have contacted the manufacturer and we have advised you.

⚠ WARNING! General Safety Rules-

FAILURE TO FOLLOW THESE RULES MAY RESULT IN SERIOUS PERSONAL INJURY. FOR YOUR OWN SAFETY, READ AND UNDERSTAND THE INSTRUCTION MANUAL BEFORE OPERATING THE MACHINE. Learn the unit's application and limitations as well as the specific hazards peculiar to it.

⚠ WARNING! General Safety Rules (Cont'd.)-

KEEP WORK AREA CLEAN. Cluttered areas and benches invite accidents. DON'T USE IN DANGEROUS ENVIRONMENT. Don't use this unit in damp or wet locations or expose it to rain. Keep work area well-lighted.

CSA Required Safety Information-

⚠ WARNING! For Your Own Safety Read Instruction Manual before Operating Table Saw.

- a.) **⚠ DANGER!** Never place your hands in the vicinity or in line with the saw blade.
- b.) **⚠ WARNING!** "Wear Eye Protection" or the Sign **M004 of ISO 7010**.
- c.) **⚠ WARNING!** Always use a properly functioning saw-blade guard, riving knife and anti-kickback device for every operation for which it can be used, including all through sawing.
- d.) **⚠ WARNING!** Use a push-stick or push-block when required.
- e.) **⚠ WARNING!** Do not perform any operation freehand.
- f.) **⚠ WARNING!** Pay particular attention to instructions on reducing risk of kickback.
- g.) **⚠ WARNING!** Never reach around or over saw blade.
- h.) **⚠ WARNING!** Turn off tool and wait for saw blade to stop before moving workpiece or changing settings.

CSA Required Safety Information (Cont'd.)-

l.) **⚠ WARNING!** Never stand directly in line with the saw blade. Always position your body on the same side of the saw blade as the fence. In addition, use hearing protection and wear gloves when handling saw blades.

Guarding Related Warnings-

a.) **⚠ WARNING!** Keep guards in place. Guards must be in working order and be properly mounted. A guard that is loose, damaged, or is not functioning correctly must be repaired or replaced.

b.) **⚠ WARNING!** Always use saw blade guard, riving knife and anti-kickback device for every through-cutting operation. For through-cutting operations where the saw blade cuts completely through the thickness of the workpiece, the guard and other safety devices help reduce the risk of injury.

c.) **⚠ WARNING!** Immediately reattach the guarding system after completing an operation (such as rabbeting, dadoing or resawing cuts) which requires removal of the guard, riving knife and/or anti-kickback device. The guard, riving knife, and anti-kickback device help to reduce the risk of injury.

d.) **⚠ CAUTION!** Make sure the saw blade is not contacting the guard, riving knife or the workpiece before the switch is turned on. Inadvertent contact of these items with the saw blade could cause a hazardous condition.

Guarding Related Warnings (Cont'd.)-

- e.) **⚠ CAUTION!** Adjust the riving knife as described in this instruction manual. Incorrect spacing, positioning and alignment can make the riving knife ineffective in reducing the likelihood of kickback.
- f.) **⚠ CAUTION!** For the riving knife and anti-kickback device to work, they must be engaged in the workpiece. The riving knife and anti-kickback device are ineffective when cutting workpieces that are too short to be engaged with the riving knife and anti-kickback device. Under these conditions a kickback cannot be prevented by the riving knife and antikickback device.
- g.) **⚠ CAUTION!** Use the appropriate saw blade for the riving knife. For the riving knife to function properly, the saw blade diameter must match the appropriate riving knife and the body of the saw blade must be thinner than the thickness of the riving knife and the cutting width of the saw blade must be wider than the thickness of the riving knife.

Cutting Procedures Warnings-

- a.) **⚠ DANGER!** Never place your fingers or hands in the vicinity or in line with the saw blade. A moment of inattention or a slip could direct your hand towards the saw blade and result in serious personal injury.
- b.) **⚠ WARNING!** Feed the workpiece into the saw blade or cutter only against the direction of rotation. Feeding the workpiece in the same direction that the saw blade is rotating above the table may result in the workpiece, and your hand, being pulled into the saw blade.
- c.) **⚠ WARNING!** Never use the MITRE gauge to feed the workpiece when ripping and do not use the rip fence as a length stop when cross cutting with the MITRE gauge. Guiding the workpiece with the rip fence and the MITRE gauge at the same time increases the likelihood of saw blade binding and kickback.
- d.) **⚠ WARNING!** When ripping, always apply the workpiece feeding force between the fence and the saw blade. Use a push stick when the distance between the fence and the saw blade is less than 150 mm and use a push block when this distance is less than 50 mm. "Work helping" devices will keep your hand at a safe distance from the saw blade.
- e.) **⚠ WARNING!** Use only the push stick provided by the manufacturer or constructed in accordance with the instructions. This push stick provides sufficient distance of the hand from the saw blade.
- f.) **⚠ WARNING!** Never use a damaged or cut push stick. A damaged push stick may break causing your hand to slip into the saw blade.

Cutting Procedures Warnings-

- g.) **⚠ WARNING!** Do not perform any operation "freehand". Always use either the rip fence or the MITRE gauge to position and guide the workpiece. "Freehand" means using your hands to support or guide the workpiece, in lieu of a rip fence or MITRE gauge. Freehand sawing leads to misalignment, binding and kickback.
- h.) **⚠ WARNING!** Never reach around or over a rotating saw blade. Reaching for a workpiece may lead to accidental contact with the moving saw blade.
- i.) **⚠ WARNING!** Provide auxiliary workpiece support to the rear and/or sides of the saw table for long and/or wide workpieces to keep them level. A long and/or wide workpiece tends to pivot on the table's edge, causing loss of control, saw blade binding and kickback.
- j.) **⚠ WARNING!** Feed workpiece at an even pace. Do not bend or twist the workpiece. If jamming occurs, turn the tool off immediately, unplug the tool then clear the jam. Jamming the saw blade by the workpiece can cause kickback or stall the motor.
- k.) **⚠ WARNING!** Do not remove pieces of cut-off material while the saw is running. The material may become trapped between the fence or inside the saw blade guard and the saw blade pulling your fingers into the saw blade. Turn the saw off and wait until the saw blade stops before removing material.
- l.) **⚠ CAUTION!** Use an auxiliary fence in contact with the tabletop when ripping workpieces less than 2 mm thick. A thin workpiece may wedge under the rip fence and create a kickback.

Kickback Causes and Related Warnings-

Statistics show that most common accidents among table saw users can be linked to kickback. Kickback is a sudden reaction of the workpiece due to a pinched, jammed saw blade or misaligned line of cut in the workpiece with respect to the saw blade or when a part of the workpiece binds between the saw blade and the rip fence or other fixed object.

Most frequently during kickback, the workpiece is lifted from the table by the rear portion of the saw blade and is propelled towards the operator.

Kickback is the result of saw misuse and/or incorrect operating procedures or conditions and can be avoided by taking proper precautions as given below:

- a.) **⚠ DANGER!** Never stand directly in line with the saw blade. Always position your body on the same side of the saw blade as the fence. Kickback may propel the workpiece at high velocity towards anyone standing in front and in line with the saw blade.
- b.) **⚠ DANGER!** Never reach over or behind the saw blade to pull or to support the workpiece. Accidental contact with the saw blade may occur or kickback may drag your fingers into the saw blade.
- c.) **⚠ DANGER!** Never hold and press the workpiece that is being cut off against the rotating saw blade. Pressing the workpiece being cut off against the saw blade will create a binding condition and kickback.

Kickback Causes and Related Warnings (Cont'd.)-

- d.) **⚠ WARNING!** Align the fence to be parallel with the saw blade. A misaligned fence will pinch the workpiece against the saw blade and create kickback.
- e.) **⚠ WARNING!** Use a feather-board to guide the workpiece against the table and fence when making non-through cuts such as rabbeting, dadoing or resawing cuts. A feather-board helps to control the workpiece in the event of a kickback.
- f.) **⚠ WARNING!** Use extra caution when making a cut into blind areas of assembled workpieces. The protruding saw blade may cut objects that can cause kickback.
- g.) **⚠ WARNING!** Support large panels to minimize the risk of saw blade pinching and kickback. Large panels tend to sag under their own weight. Support(s) must be placed under all portions of the panel overhanging the tabletop.
- h.) **⚠ WARNING!** Use extra caution when cutting a workpiece that is twisted, knotted, warped, or does not have a straight edge to guide it with a MITRE gauge or along the fence. A warped, knotted, or twisted workpiece is unstable and causes misalignment of the kerf with the saw blade, binding and kickback.
- i.) **⚠ WARNING!** Never cut more than one workpiece, stacked vertically or horizontally. The saw blade could pick up one or more pieces and cause kickback.

Kickback Causes and Related Warnings (Cont'd.)-

j.) **⚠ WARNING!** When restarting the saw with the saw blade in the workpiece, center the saw blade in the kerf so that the saw teeth are not engaged in the material. If the saw blade binds, it may lift the workpiece and cause kickback when the saw is restarted.

k.) **⚠ WARNING!** Keep saw blades clean, sharp, and with sufficient set. Never use warped saw blades or saw blades with cracked or broken teeth. Sharp and properly set saw blades minimize binding, stalling and kickback.

Table Saw Operating Procedure Warnings-

1.) **⚠ WARNING!** Turn off the table saw and disconnect the power cord when removing the table insert, changing the saw blade or adjusting the riving knife, anti-kickback device or saw blade guard, and when the machine is left unattended. Precautionary measures will avoid accidents.

2.) **⚠ WARNING!** Never leave the table saw running unattended. Turn it off and don't leave the tool until it comes to a complete stop. An unattended running saw is an uncontrolled hazard.

3.) **⚠ WARNING!** Locate the table saw in a well-lit and level area where you can maintain good footing and balance. It should be installed in an area that provides enough room to easily handle the size of your workpiece. Cramped, dark areas, and uneven, slippery floors invite accidents.

4.) **⚠ WARNING!** Frequently clean and remove sawdust from under the saw table and/or the dust collection device. Accumulated sawdust is combustible and may self-ignite.

Table Saw Operating Procedure Warnings (Cont'd.) -

- 5.) **⚠ WARNING!** The table saw must be secured. A table saw that is not properly secured may move or tip over.
- 6.) **⚠ WARNING!** Remove tools, wood scraps, etc. from the table before the table saw is turned on. Distraction or a potential jam can be dangerous.
- 7.) **⚠ WARNING!** Always use saw blades with correct size and shape (diamond versus round) of arbor holes. Saw blades that do not match the mounting hardware of the saw will run off-center, causing loss of control.
- 8.) **⚠ CAUTION!** Never use damaged or incorrect saw blade mounting means such as flanges, saw blade washers, bolts, or nuts. These mounting means were specially designed for your saw, for safe operation and optimum performance.
- 9.) **⚠ CAUTION!** Never stand on the table saw, do not use it as a stepping stool. Serious injury could occur if the tool is tipped or if the cutting tool is accidentally contacted.
- 10.) **⚠ CAUTION!** Make sure that the saw blade is installed to rotate in the proper direction. Do not use grinding wheels, wire brushes, or abrasive wheels on a table saw. Improper saw blade installation or use of accessories not recommended may cause serious injury.

Grounding Instructions-

TABLE A						
Ampere Rating		Volts	Total length of cord in feet			
		120	25	50	100	150
		240	50	100	200	300
more than	not more than		Minimum gage for cord			
0	6		18	16	16	14
6	10		18	16	14	12
10	12		16	16	14	12
12	16		14	12	NO	NO

Grounding Methods-

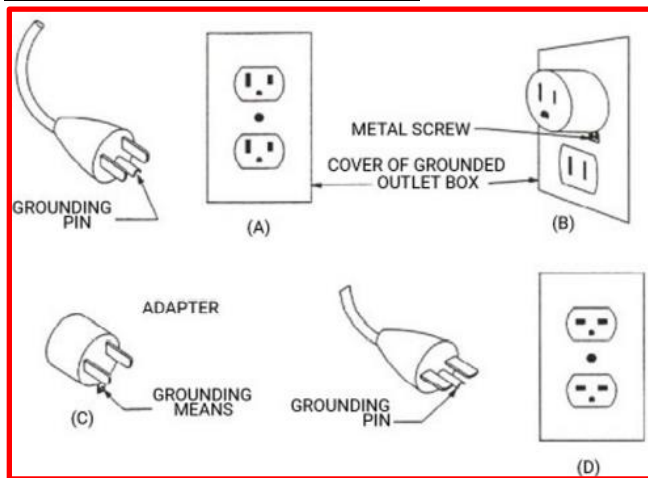

Figure 1.) Grounding Methods Provided by CSA (Canadian Standards Association) Group. Sketches A.), B.) C.) & D.)-

- (A) Receptacle with nominal rating less than 150 volts.
- (B) 150-Volt receptacle without grounding pin fitted with adapter.
- (C) Grounding receptacle adapter.
- (D) Receptacle with nominal rating between 150 - 250 volts.

All grounded, cord-connected tools:

In the event of a malfunction or breakdown, grounding provides a path of least resistance for electric current to reduce the risk of electric shock. This tool is equipped with an electric cord having an equipment-grounding conductor and a grounding plug. The plug must be plugged into a matching outlet that is properly installed and grounded in accordance with all local codes and ordinances.

- a.) **⚠ WARNING!** Do not modify the plug provided; if it will not fit the outlet, have the proper outlet installed by a qualified electrician.
- b.) **⚠ WARNING!** Improper connection of the equipment-grounding conductor can result in a risk of electric shock. The conductor with insulation having an outer surface that is green with or without yellow stripes is the equipment-grounding conductor. If repair or replacement of the electric cord or plug is necessary, do not connect the equipment-grounding conductor to a live terminal.
- c.) Check with a qualified electrician or service personnel if the grounding instructions are not completely understood, or if in doubt as to whether the tool is properly grounded.
- d.) Use only 3-wire extension cords that have 3-prong grounding plugs and 3 pole receptacles that accept the tool's plug.
- e.) Repair or replace damaged or worn cord immediately.
- f.) Grounded, cord-connected tools intended for use on a supply circuit having a nominal rating less than 150 volts:

All Grounded, Cord-Connected Tools:

g.) This tool is intended for use on a circuit that has an outlet that looks like the one illustrated in Sketch A in Fig. 1. The tool has a grounding plug that looks like the plug illustrated in Sketch A in Fig. 1. A temporary adapter, which looks like the adapter illustrated in Sketch B and C, may be used to connect this plug to a 2-pole receptacle as shown in Sketch B if a properly grounded outlet is not available. The temporary adapter should be used only until a properly grounded outlet can be installed by a qualified electrician. This adapter is not permitted in Canada. The green-colored rigid ear, lug, and the like, extending from the adapter must be connected to a permanent ground such as a properly grounded outlet box.

h.) Grounded, cord-connected tools intended for use on a supply circuit having a nominal rating between 150 – 250 volts, inclusive:

l.) This tool is intended for use on a circuit that has an outlet that looks like the one illustrated in Sketch D. The tool has a grounding plug that looks like the plug illustrated in Sketch D. Make sure the tool is connected to an outlet having the same configuration as the plug. No adapter is available or should be used with this tool. If the tool must be reconnected for use on a different type of electric circuit, the reconnection should be made by qualified service personnel; and after reconnection, the tool should comply with all local codes and ordinances.

Safety (FRENCH)

AVERTISSEMENT! –

Pour votre propre sécurité, lisez le manuel d'instructions avant d'utiliser la scie à table.

(a) DANGER - Ne placez jamais vos mains à proximité ou en ligne avec la lame de scie.

(b) AVERTISSEMENT - "Porter une protection oculaire" ou le signe M004 de la norme ISO 7010.

(c) AVERTISSEMENT - Toujours utiliser un protecteur de lame de scie, un couteau diviseur et un dispositif anti-retour pour chaque opération pour laquelle il peut être utilisé, y compris tout au long du sciage.

(d) AVERTISSEMENT - Utiliser un bâton-poussoir ou un bloc-poussoir au besoin.

(e) AVERTISSEMENT - N'effectuez aucune opération à main levée.

(f) AVERTISSEMENT - Porter une attention particulière aux instructions sur la réduction du risque de rebond. (ou "Savoir comment réduire les risques de pots-de-vin.")

(g) AVERTISSEMENT - Ne jamais tendre la main autour ou au-dessus de la lame de scie. (ou "Ne jamais tendre la main à l'arrière ou au-dessus de la lame de scie").

(H) AVERTISSEMENT - Éteindre l'outil et attendre que la lame de scie s'arrête avant de déplacer la pièce ou de changer les réglages.

(I) AVERTISSEMENT - Ne jamais se tenir directement en ligne avec la lame de scie. Placez toujours votre corps du même côté de la lame de scie que la clôture.

De plus, utilisez une protection auditive et portez des gants pour manipuler les lames de scie.

Avertissements relatifs à la protection.

Safety (FRENCH)

AVERTISSEMENT! (Cont'd.) –

Laisser les protecteurs en place. Les protecteurs doivent être en état de fonctionnement et montés correctement. Un protecteur mal fixé, endommagé ou ne fonctionnant pas correctement doit être réparé ou remplacé.

Toujours utiliser un protecteur de lames, un couteau diviseur et un appareil antirecul pour toute opération de coupe traversante.

Pour les opérations de coupe traversante où la lame traverse complètement l'épaisseur de la pièce, le protecteur et les autres appareils de sécurité contribuent à limiter le risque de blessure. Fixer de nouveau immédiatement le protecteur après l'exécution d'une opération (telle que le refeuillement, l'engravure ou la refente) qui nécessite l'enlèvement du protecteur, du couteau diviseur et/ou de l'appareil anti-recul. Le protecteur, le couteau diviseur et l'appareil anti-recul contribuent à limiter le risque de blessure.

Veiller à ce que la lame n'entre pas en contact avec le protecteur, le couteau diviseur ou la pièce avant le déclenchement du commutateur.

Un contact involontaire de ces éléments avec la lame pourrait entraîner un fonctionnement dangereux.

Ajuster le couteau diviseur comme décrit dans la notice d'utilisation.

Un espacement, un positionnement et un alignement incorrects peuvent empêcher le couteau diviseur de limiter le risque de recul.

Pour que le couteau diviseur et l'appareil anti-recul fonctionnent, ils doivent être engagés dans la pièce.

Safety (FRENCH)

AVERTISSEMENT! (Cont'd.) –

Le couteau diviseur et l'appareil anti-recul sont inefficaces lorsque l'on coupe des pièces trop courtes pour que le couteau diviseur et l'appareil antirecul puissent s'y engager.

Dans ces conditions, le couteau diviseur et l'appareil anti-recul ne peuvent pas empêcher un recul de se produire.

Utiliser la lame appropriée au couteau diviseur.

Pour que le couteau diviseur fonctionne correctement, le diamètre de la lame doit correspondre au couteau diviseur approprié, l'épaisseur de la lame de scie doit être plus mince que celle du couteau diviseur et la largeur de coupe de la lame de scie doit être supérieure à l'épaisseur du couteau diviseur.

Avertissements relatifs aux modes opératoires de coupe **DANGER:** Ne jamais mettre les doigts ou les mains à proximité ou dans l'alignement de la lame.

Votre main pourrait glisser ou se diriger vers la lame dans un moment d'inattention et entraîner une blessure grave. Avancer la pièce en direction de la lame ou du couteau uniquement dans le sens inverse de rotation.

L'avance de la pièce dans le même sens que le sens de rotation de la lame au-dessus de la table peut entraîner la pièce et la main dans la lame.

Ne jamais utiliser le guide inclinable pour avancer la pièce lors d'un sciage en long et ne pas utiliser le guide longitudinal comme butée longitudinale lors d'un sciage en travers à l'aide du guide inclinable. Le guidage de la pièce en utilisant en même temps le guide longitudinal et le guide inclinable augmente le risque de blocage de la lame et de recul.

Safety (FRENCH)

AVERTISSEMENT! (Cont'd.) –

Ne jamais couper plusieurs pièces empilées verticalement ou horizontalement. La lame pourrait attraper plusieurs pièces et provoquer un recul.

Lors d'un redémarrage d'une scie avec une lame de scie dans la pièce, centrer la lame dans le trait de scie de sorte que les dents ne pénètrent pas dans le matériau.

Si la lame se bloque, elle peut soulever la pièce et provoquer un recul lors du redémarrage de la scie. Maintenir les lames propres, bien aiguisées et avec un écart latéral suffisant. Ne jamais utiliser des lames gauchies ou des lames dont les dents sont fissurées ou cassées.

Des lames bien aiguisées et ayant un bon écart latéral limitent le risque de blocage, de calage et de recul.

Avertissements relatifs au mode opératoire de fonctionnement de la scie circulaire à table Arrêter le fonctionnement de la scie circulaire et débrancher le cordon d'alimentation lors de l'enlèvement de la plaque amovible, du remplacement de la lame de scie ou des réglages du couteau diviseur, de l'appareil anti-recul ou du protecteur de lame, et lorsque la machine est laissée sans surveillance.

Ces mesures de précaution éviteront les accidents.

Ne jamais laisser la scie circulaire à table fonctionner sans surveillance. Arrêter le fonctionnement et ne pas quitter l'outil tant qu'il n'a pas cessé de fonctionner. Une scie fonctionnant sans surveillance est un danger incontrôlé.

Placer la scie circulaire à table dans un endroit bien éclairé et sur une surface plane où elle peut être maintenue bien en appui et en équilibre. Il convient de l'installer dans un endroit qui prévoit une place suffisante pour pouvoir manipuler facilement la pièce quelle que soit sa taille. Des

Safety (FRENCH)

AVERTISSEMENT! (Cont'd.) –

endroits exigus, sombres et des sols inégaux et glissants sont susceptibles de provoquer des accidents. Nettoyer fréquemment et enlever la sciure accumulée sous la scie circulaire à table et/ou sous l'appareil de dépoussiérage.

La sciure accumulée est combustible et peut s'enflammer. La scie circulaire à table doit être immobilisée. Une scie circulaire à table mal immobilisée peut bouger ou basculer. Enlever les outils, copeaux de bois, etc. de la table avant de faire fonctionner la scie.

Un moment d'inattention ou un coincement éventuel peut être dangereux. Toujours utiliser des lames de scie de dimensions et de forme appropriées des alésages centraux (lame de scie au diamant contre lame de scie ronde).

Des lames qui ne sont pas conformes aux matériels de montage de la scie seront excentrées, provoquant une perte de contrôle.

Ne jamais utiliser des appareils de montage, tels que des flasques, des rondelles de lame, des boulons ou écrous, endommagés ou inadaptés.

Ces appareils de montage ont été spécialement conçus pour être utilisés avec votre scie, à des fins de fonctionnement sûr et de performance optimale. Ne jamais se tenir sur la scie circulaire à table, ne pas l'utiliser comme tabouret. Des blessures sérieuses peuvent survenir si l'outil bascule ou en cas de contact accidentel avec l'outil de coupe. Veiller à ce que la scie circulaire à table soit installée de façon à tourner dans la bonne direction. Ne pas utiliser des meules, des brosses métalliques ou des disques abrasifs sur une scie circulaire à table. Une installation incorrecte de la lame ou l'utilisation d'accessoires non recommandés peut entraîner de graves blessures.

Inventory List-

Your F3 Fusion table saw will likely be delivered by a third-party delivery service. Before unpacking your new machine, first inspect the packaging, the invoice, and the shipping documents supplied by the driver. When unpacking your table saw, separate all enclosed items from the packing materials and inspect them for damages. Ensure that there is no visible damage to either the packaging or the machine BEFORE the driver leaves. Save all packaging materials until you are satisfied with the machine and/or have resolved any issues concerning any missing or damaged items.

IMPORTANT! All shipping damage must be noted upon delivery and signed by the owner and the delivery driver. If you find any damaged items in your package, you must contact Laguna Tools to file a complaint. To return damaged goods under the limited warranty to Laguna Tools, Inc., you MUST have the original packaging. All claims of loss or damaged goods must be reported to Laguna Tools within 24 HOURS of delivery. Please contact the Laguna Tools, Inc. Customer Service Department to make claims for any damaged items/parts.

Complete F3 Fusion Table Saw Packaging-

TECH TIP Table saw items/parts arrive individually boxed inside the wooden crate.

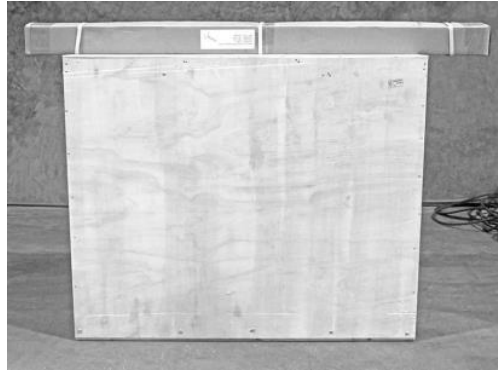

SAFETY TIPS:

- 1.) Have an additional person help to remove heavy items from the machine packaging.
- 2.) First-time users should consult with an experienced user or professional before attempting to operate the saw.
- 3.) To reduce your risk of injury read the entire manual BEFORE operating the machine.









Loose Parts Inventory-

The following depicts items shipped with your machine. Before assembling your saw, ensure that you have received all parts shown below. Machine parts should arrive sealed in plastic bags. Remove parts from plastic bags before laying them out to inventory them.

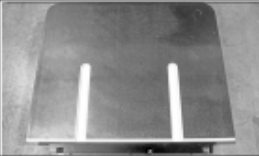





WARNING! Have another person help to lift or remove heavier items (such as the table saw body) from the packaging.

TECH TIP For your convenience, this table lists where individual boxes parts can be found in.

Loose Parts Inventory (Cont'd.)-

REF	Description	Q	PACKAGING
	F3 Table	1	Wooden Crate
	Right Extension Table	1	Boxed Individually
	Right Extension Legs	2	Boxed with Outboard Table
	Rear Extension Table	1	Boxed Individually
	Rear Extension Table Legs	2	Each leg Boxed individually
	Miter Gauge	1	Boxed Individually
	Dust Collection Hose	1	Plastic Wrapped Individually
	Blade Guard Assembly	1	Boxed Individually
	Fence Assembly	1	Boxed Individually

Loose Parts Inventory (Cont'd.)-

REF	Description	Q	PACKAGING
	Fence Lock Knob	1	Boxed w/ Fence Assembly
	Push Stick	1	Boxed w/ Fence Assembly
	Left Side Front Rail	1	Boxed w/ Fence Assembly
	Front Rail Assembly	1	Boxed Individually
	Rear Rail Assembly	1	Boxed with Steel Rail
	Control Switch	1	Attached to table
	Dust Collector Hose	1	Boxed Individually







Ensure your package contains all the proper parts/items to assemble your machine. Be sure to cross reference the chart with both the quantity and image to ensure you have received all proper parts.







TECH TIP

Listed are the items included in the package, this list does not include additional tools/hardware which may be necessary to assemble your F3 Fusion table saw.

Hardware Inventory-

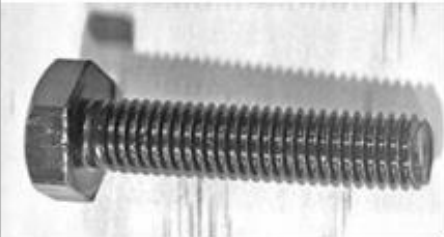
Listed below are all the hardware required for assembly of the Fusion F3 table saws. The hardware below has been included in the Fusion F3's packaging. As you inventory the other parts shipped with your machine, be sure to inventory and familiarize yourself with the hardware listed below.

Ref.	Description	Q	Installation
A 	Counter-Sunk Alan Head Screws (25mm) use with hex nuts(F), flat washers(H)	7	Front Rail Assembly, F3 Table Also used to fasten Right Extension Table
B 	Socket head Button Screw w/ Lock Washer (28mm) use with hex nuts(F), flat washers(H)	4	Rear Rail Assembly, F3 Table Dust collector hose support, F3 Table
C 	Hex Cap Screw w/ Flat Washer (longer)	5	Rear Extension Table, F3 Table Control Switch, Left Front Rail
D 	Socket Head Cap Screw (no washer) (28mm) use with use with hex nuts(F), lock washers (E)	5	Rear Rail Assembly, F3 Table
E 	Hex Cap Bolt (30mm) use with hex nuts(F), lock washers (E)	2	Left Side Front Rail Assembly, F3 Table
F 	Hex Nuts (13mm)	20	Multiple

Ref.	Description	Q	Installation
G 	Flat Washers (8mm)	17	Multiple
H 	Lock Washers (8mm)	8	Multiple
I 	Hex Cap Bolt (51mm) use with Nylon Lock Nuts(H)	4	Rear Extension Table Legs, Rear Extension table
J 	Nylon Lock Nuts (16mm)	4	Rear Extension Table Legs, Rear Extension table
K 	Rubber Feet	2	F3 Table (Bottom)
L 	Hex Cap Screw w/ Flat Washer (shorter)	9	Front Body to Front Rail (left & right side)

Accessory Hardware & Tools-



The hardware and tools listed below come individually wrapped in plastic bags.

General Tools: Dual-Sided Wrench and Allen Wrenches-



Band Clamp with Hex Bolt, Flat Washer, and Hex Nut-



Fence Hooks and Hex Bolts with Flat Washers-



Set-Up-

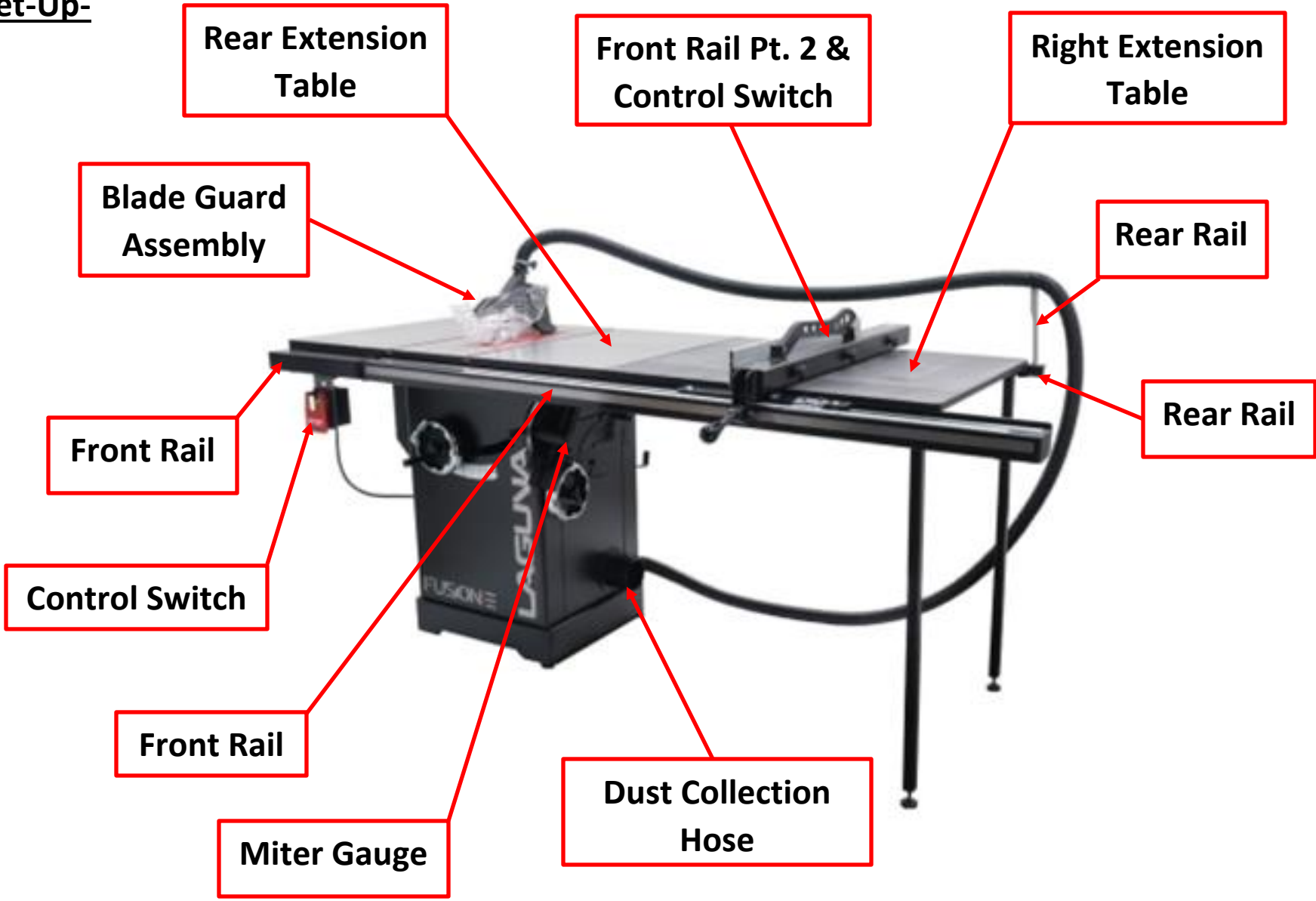

Unboxing-

Your Fusion F3 table saw was carefully packaged for safe transport. The table saw should arrive attached to a wooden pallet and covered by a wooden crate housing the table saw and its accessories. When unpacking your machine, separate all enclosed materials to ensure that there are no damages to the parts you've received.

⚠ WARNING! This machine is heavy. If you have any doubt about the following unboxing or set up procedures seek assistance from an experienced professional. DO NOT attempt any procedure that you feel is unsafe or that you feel you do not have the physical capability of achieving.

⚠ CAUTION! Do not cut deep into the wooden crate with a blade as it may scratch the paint of the table saw. To prevent this, only use a dull edge or cut deep enough to only puncture the tape.

🔧 TECH TIP Before setting up your machine, organize all additional set-up tools.

🔧 TECH TIP The package will arrive fitted to a wooden pallet.

Quick Reference Guide

Add. Required Tools: <ul style="list-style-type: none">• Phillips head Screw Driver• Standard wrench• Shop Rag• WD40 (Cleaning solvent)
Troubleshooting/Tips: <p>Use at least two people to lift the wooden crate covering the table saw and its accessories.</p>

For this assembly, you will need:
<ul style="list-style-type: none">• Packaged Fusion F3 Table saw• 13 mm socket wrench or general wrench

Unboxing (Cont'd.)-

1.) Using a Phillips head screwdriver, remove the screws lining the bottom of the wooden crate. This will release the crate covering from the wooden pallet.

Shipped Carton



Bolt Locations

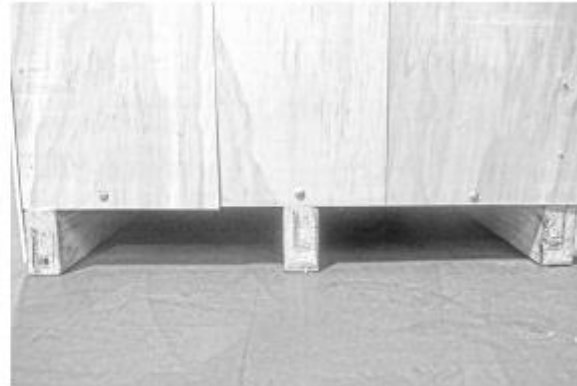

Screwing out skid bolts

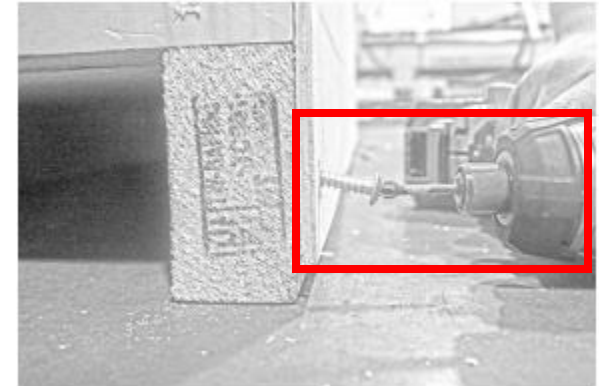

⚠ WARNING! You will need TWO OR MORE people to assist in completing step two.

2.) With another person, lift the wooden crate off the wooden pallet. The table saw and individually boxed accessories will be located beneath.

3.) Remove individually packaged items and inventory parts to ensure all parts have arrived undamaged.

Unboxing (Cont'd.)-

Un-crated carton



Removing the table saw from the wooden pallet:

🔧 TECH TIP

The table saw will arrive secured to the wooden pallet.

1.) Using the 13mm Socket Wrench provided or a standard wrench, loosen the bolts attaching the table saw to the pallet's metal "L" brackets.

Bolt Removal

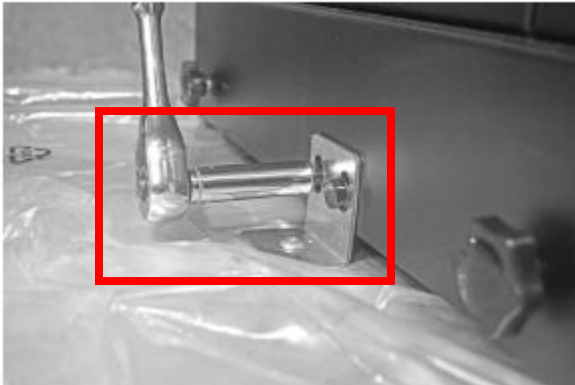

⚠️ WARNING! It is recommended that **TWO OR MORE people assist** in completing step two. However, one person can complete the remaining unboxing steps without further assistance.

2.) Preferably with another person, slowly walk the table saw off the wooden pallet.

3.) For safe assembly, place the table saw in a well-lit, location free of any debris or obstructions.

Unboxing (Cont'd.)-

Table Saw Mobility:

1.) At the base of the table saw, there are two lock knobs (shown right) which allow the user to adjust the wheels located beneath the table saw. Tightening the knobs will lock the table saw's wheels. Loosen the knobs to allow wheels to move. After the knobs have been adjusted, lift the table saw from the opposite end (like a Wheelbarrow or Wheel barrel).

Knob Location

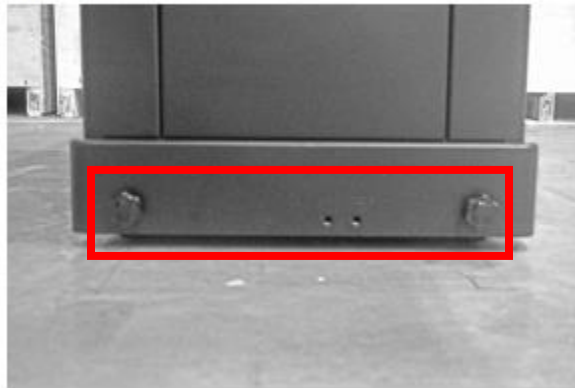

Loosening Lock Knobs

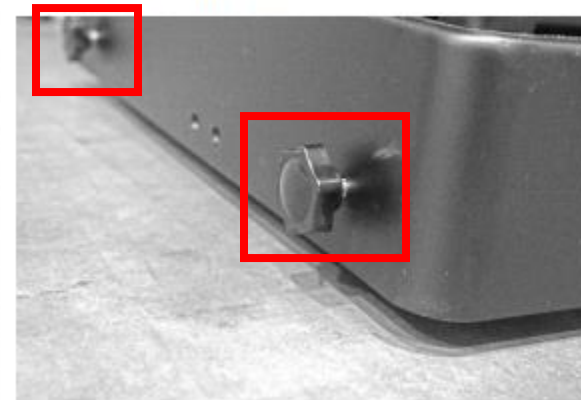

Assembly-

Front Rail-

The Fusion F3 table saw's front rail assembly houses the front rail and guide ruler. In conjunction with the rear rail, the front rail allows the fence to move fluidly across the table. The front rail assembly is made up of the left and right front rail brackets, the front rail, and the control switch.

TECH TIP

Before setting up your machine, organize all additional set-up tools.

Quick Reference Guide





Add. Required Tools:

- Level
- Allen Wrenches
- General Wrench

Troubleshooting/Tips:

Attaching the rubber feet to the rear extension legs before attaching the legs to the front rail bracket will make for easier assembly.

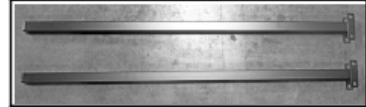
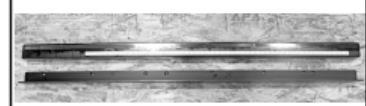



Parts

REF	Description	Q	Installation
	Right Extension Legs	2	Front Rail Assembly
	Front Rail Assembly (Only the front rail bracket is needed)	1	F3 Table
	Left Side Front Rail	1	F3 Table Rail Body

Hardware

REF	Description	Q	Installation
A 	Counter-Sunk Alan Head Screws (25mm) use with hex nuts(F), flat washers(H)	5 of 7	Front Rail Assembly, F3 Table Also used to fasten Right Extension Table
F	Hex Nuts (13mm)	5 of 20	Front Rail Assembly, F3 Table

Front Rail (Cont'd.)-

Hardware			
			
G 	Flat Washers (8mm)	5 of 17	Front Rail Assembly, F3 Table
E 	Hex Cap Bolt (30mm) use with hex nuts(F), lock washers (E)	2 of 2	Left Side Front Rail Assembly, F3 Table
H 	Lock Washers (8mm)	2 of 8	Left Side Front Rail Assembly, F3 Table
K 	Rubber Feet	2 of 2	Right Extension Leg

Attaching the Rubber Feet to the Right Extension Legs:

- 1.) Locate the threaded holes on the bottom of each of the right extension legs.
- 2.) Thread each rubber foot through the right extension leg's bottom threaded holes.
- 3.) Hand tightens each foot to start. Later, the foot may need to be loosened or tightened to properly level the front and rear rails.

Correctly installed foot:



TECH TIP

You may assemble both right extension legs at this step, though only one will be used to complete the following steps.

Attaching the Extension Legs to the Front Rail Bracket:

- 1.) Align the right extension leg's bolt holes with the matching set of holes on the front rail bracket (located on the far right of the bracket).
- 2.) Thread the counter-sunk bolts from the front rail through to the extension leg.
- 3.) Thread a lock washer and hex nut to on the back of the counter-sunk bolt.
- 4.) Secure the counter-sunk bolt to the front rail using an Allen wrench.

Front View

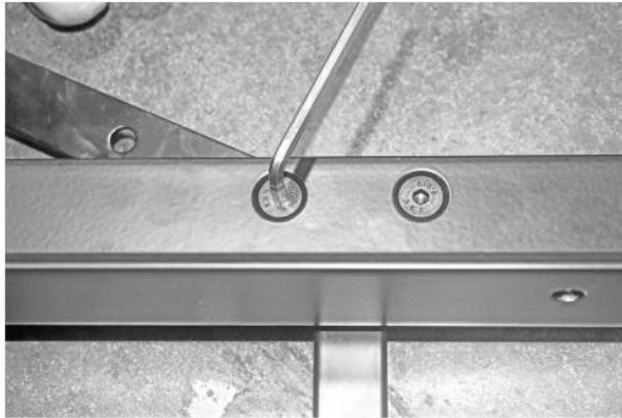

Rear View



Attaching the Right Front Rail to the Table:

- 1.) Align the front brackets through holes with the through holes on the front of the table.

TECH TIP

The front rail bracket has three through-holes which should align with the last three through-holes on the front of the table located on the far right as shown.

Attaching the Right Front Rail to the Table (Cont'd.):

- 2.) Thread three counter-sunk screws through each of the front rail's through-holes.
- 3.) Thread the flat washers and hex nuts onto the back of each counter-sunk bolt.
- 4.) Use a level to ensure that the front rail is level to the table. If needed, you may adjust the height of the extension leg to level the bracket with the table.
- 5.) After the bracket has been leveled, tighten the counter-sunk bolts with the wrench provided to secure the bracket to the table.

🔧 TECH TIP

After completing Step 4.)-four, there should be 2-two through holes in the middle of the front rail bracket which have not been used yet. These should be empty as they will be used to mount the right extension table later.

Three Front Rail Counter-Sunk Bolts

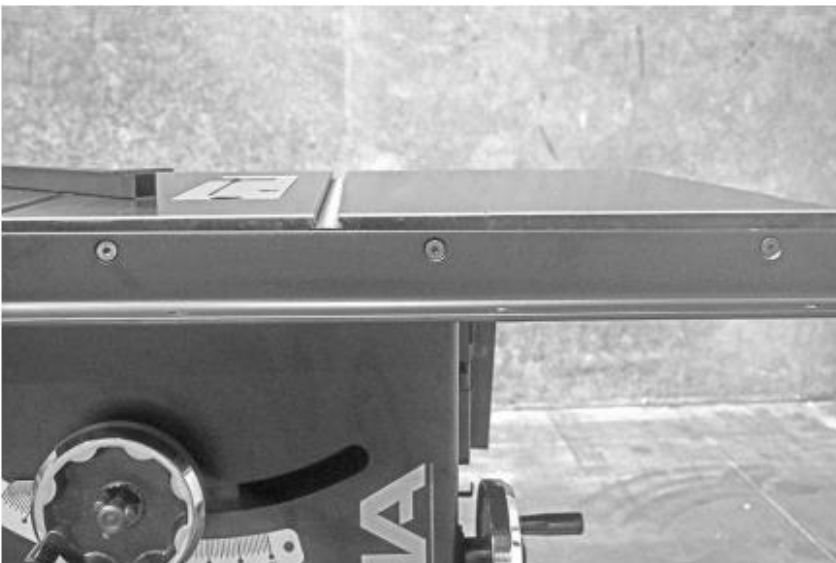

Flat Washer and Hex Nut (secured to the table)



Attaching the Right Front Rail to the Table (Cont'd.):

Middle counter-sunk through holes (empty):



Attaching the Left Front Rail to the Table:

1.) Align the left front rail's bolt holes with the bolt holes on the front of the table saw.



TECH TIP These bolt holes will be located to the far left on the front of the table.

2.) Place a lock washer onto the head side of the 30 mm hex bolts. Then thread two 30 mm hex bolts through each of the left front rail's bolt holes.

3.) Thread a flat washer and hex nut onto the back of the 30 mm hex bolt.

4.) Hand-tighten the bolts to secure the left front rail to the table. Then, use a level to ensure that the left front rail bracket is leveled.

Attaching the Left Front Rail to the Table (Cont'd.):

5.) After the left front rail bracket has been leveled, tighten the hex bolts using the wrench provided.

Left front rail and level

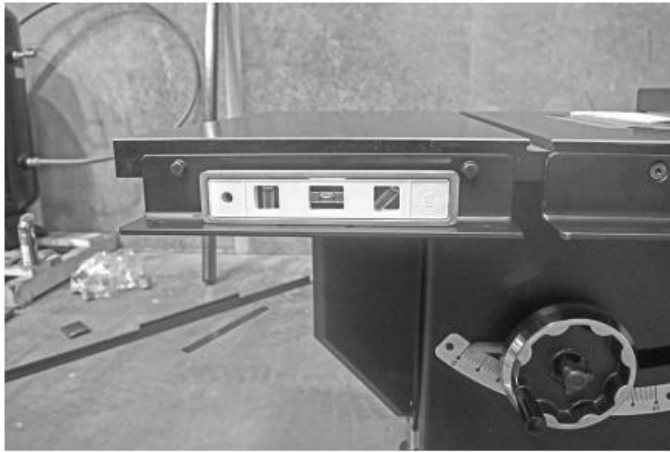





Flat Washer and Hex Nut (secured to the table)



Rear Rail-

The Fusion F3 table saw's rear rail assembly supports both the fence and the rear extension table attachment. In conjunction with the front rail, the rear rail allows the fence to move fluidly across the table. The rear rail assembly is made up of the left and right rear rail bracket, the dust collector hose support bracket, the rear rail bracket.

Quick Reference Guide

Add. Required Tools: <ul style="list-style-type: none"> • Level • Allen Wrenches • General Wrench
Troubleshooting/Tips: Attaching the dust collector hose support to the right rear rail bracket BEFORE attaching the right extension leg to the bracket will make for easier assembly.

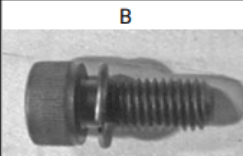
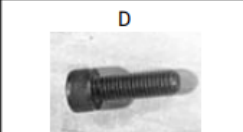
Parts			
REF	Description	Q	Installation
	Right Extension Legs (now assembled)	2	Assembled to F3 Table
	Rear Rail Assembly	1	F3 Table
	Dust Collector Hose	1	Right Rear Rail Bracket

Hardware			
REF	Description	Q	Installation
	Socket head Button Screw w/ Lock Washer (28mm) use with hex nuts(F), flat washers(H)	4 of 4	Rear Rail Assembly, F3 Table Dust collector hose support, F3 Table
	Socket Head Cap Screw (no washer) (28mm) use with hex nuts(F), flat washers(H), lock washers(H)	3 of 5	Rear Rail Assembly, F3 Table

Hardware			
	Hex Nuts (13mm)	7 of 20	Rear Rail Assembly, F3 Table
	Flat Washers (8mm)	7 of 17	Rear Rail Assembly, F3 Table
	Lock Washers (8mm)	3 of 8	Rear Rail Assembly, F3 Table

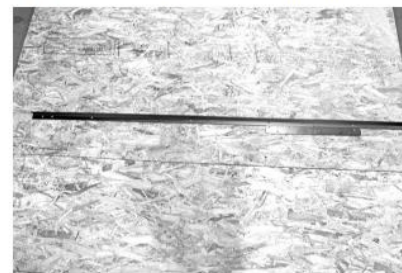
From left to right: Right Rear Rail Bracket, Left Rear Rail Bracket, Rear Rail Bracket (centered).



Attaching the Rear Extension Leg and Dust Collector Hose Support Bracket to the Right Rear Rail Bracket:

TECH TIP

You will need to attach the dust collector hose support bracket to the right rear rail bracket, as they share an assembly bolt.

- 1.) Align the right extension leg with the matching set of bolt holes at the end of the right rear rail bracket.
- 2.) Using one socket head cap screw, secure the right extension leg to the rear right rail bracket. This will ensure that the leg does not move as the dust collector hose support is being attached to the rail and extension leg.
- 3.) Align the dust collector hose support's bolt hole with the bolt hole farthest right on the right rear rail bracket. The dust collector hose should then also be aligned with the extension leg's furthest right bolt hole.
- 4.) Secure the dust collector hose support, right rear rail bracket, and right extension leg to the table.

TECH TIP

Thread lock washers to the head of the screws. Secure flat washers and hex nuts to the back of the screw.

Top View:



Front View:



Attaching the Rear Extension Leg and Dust Collector Hose Support Bracket to the Right Rear Rail Bracket (Cont'd.):

Rear View:



Hose support and Leg properly Installed:



Attaching the Right Rear Rail Bracket to the Table:

1.) Align the right rear rail bracket's bolt holes with the bolt holes located on the back of the table as shown below:

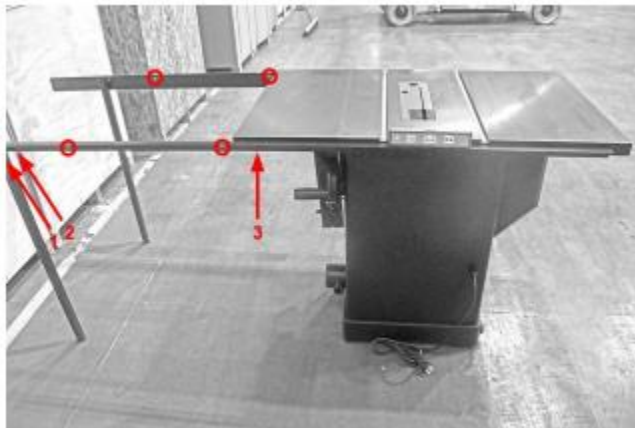

Attaching the Right Rear Rail Bracket to the Table (Cont'd.):

2.) Thread 1 socket head cap screws and lock washer through the rear rail and tables through holes. At this stage, only three socket head cap screws should be used to secure the rail to the table (see above image).

3.) Thread flat washer and hex nut and snugly tighten, allowing play.

TECH TIP After completing step 2.)-two, there should be two through holes in the middle of the front rail bracket which has not been used yet. These should be empty as they will be used later to mount the right extension table (shown above as red circles).

Attaching the Left Rear Rail Bracket and Rear Bracket to the Table:

1.) Align the left rear rail bracket's threaded bolt holes with the bolt holes located on the far left of the table saw.

2.) Place the rear rail bracket over the right and left rear rail brackets. (As pictured below).

3.) Align the rear rail's bolt holes with the left and right rear rail's bolt holes as shown.

4.) Thread socket head cap screws and lock washers through the rear rail assembly.

5.) Thread flat washers and hex bolts on to the back of the socket head cap screws, make sure the rails are level to the table, and tighten to secure all brackets to the table.

TECH TIP Ensure that the through holes (not the threaded holes) on the rear rail brackets are used for this step. The threaded holes will be used later to attach the rear extension table to the table saw.

Attaching the Left Rear Rail Bracket and Rear Bracket to the Table (Cont'd.):

Leveling:





Bolt Tightening and arrangement: Bolt, lock washer // flat washer, nut







Right Extension Table-

The Fusion F3 table saw's right extension table supports both the fence and the work piece. In conjunction with the front rail, the right extension table allows the fence to move fluidly across the table to adjust to the width of the wood piece being cut.

Quick Reference Guide

Add. Required Tools: <ul style="list-style-type: none"> • Level • Allen Wrenches • General Wrench
Troubleshooting/Tips: Be sure that the right extension table's grooves are fitted snugly on the threads of the screws/bolts before securing the extension table to the rear rails.

Parts			
REF	Description	Q	Installation
	Right Extension Table	1	Right Rear Rail, F3 Table, Right Front Rail

Hardware			
REF	Description	Q	Installation
	Counter-Sunk Alan Head Screws (25mm) use with hex nuts(F), flat washers(H)	2 of 7	Front Rail Assembly, F3 Table, Right Extension Table
	Socket Head Cap Screw (no washer) (28mm) use with hex nuts(F), flat washers(H), lock washers(H)	2 of 5	Rear Rail Assembly, F3 Table, Right Extension Table
	Hex Nuts (13mm)	4 of 20	Multiple
	Flat Washers (8mm)	4 of 17	Multiple

Hardware			
			
	Lock Washers (8mm)	2 of 8	Socket Head Cap Screw

Mounting the Table Extension:

- 1.) Thread two counter sunk bolts through the two empty through holes on the front rail bracket.
- 2.) Thread two socket head cap screws through the empty bolt holes on the right ear rail bracket.
- 3.) Place the right extension table's grooves on top of the socket head and counter-sunk screws respectively. Ensure that each of the four the grooves are securely rested on the threads of each of the exposed screws.
- 4.) Thread flat washers and hex nuts on the backs of each of the screws. Use the wrench to tighten the bolts and secure the extension table to the front and rear rails.

Pre-Installation:



Underside Bracket (the picture does not show a flat washer used, please use one)





Completed installation:





Rear Extension Table-

The Fusion F3 table saw's rear extension table supports both the fence and the work piece. In conjunction with the rear rail, the rear extension table provides an extra support table for the length of the wood piece being cut.

Quick Reference Guide

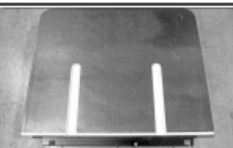
Add. Required Tools: <ul style="list-style-type: none"> • Level • General Wrench • 17mm socket wrench (optional)
Troubleshooting/Tips: For easiest assembly, flip the rear extension table so that the face is down. After the table has been flipped, attach the rear extension legs to the table.

Hardware			
			

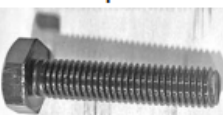
Parts			
REF	Description	Q	Installation
	Rear Extension Table	1	Rear Rail Assembly, F3 Table
	Rear Extension Table Legs	2	Rear Extension Table

Hardware			
REF	Description	Q	Installation
C 	Hex Cap Screw w/ Flat Washer (longer)	3 of 5	Rear Extension Table, F3 Table
I 	Hex Cap Bolt (51mm) use with Nylon Lock Nuts(H)	4 of 4	Rear Extension Table Legs, Rear Extension table
J	Nylon Lock Nuts (16mm)	4 of 4	Rear Extension Table Legs, Rear Extension table

Attaching Legs to the Rear Extension Table:

- 1.) Flip the rear extension table so that the face is down.
- 2.) Place the rear extension legs between the metal L-brackets on either side of the table.
- 3.) Align the rear extension leg's bolt holes with bracket's bolt holes. Ensure that the rear extension leg's bolt holes are aligned with the last two bolt holes of the metal bracket.
4. Thread the 51 mm hex bolts through the metal L-bracket.
5. Thread nylon lock nuts on to the back of the hex bolts. Tighten with a wrench or a 17 mm socket wrench (optional).

Attaching legs to table:



Securing Bolts

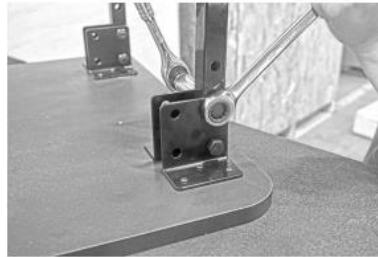

Installed Legs



Attaching the Rear Extension Table to the Table Saw:

1. Locate the three through holes on the back mounting bracket of the rear extension table.
2. Align these three through holes with the three threaded holes on the rear support bracket.
3. Thread one of the three (longer) Hex Bolt with Flat Washer through each of the threaded holes.

TECH TIP

The height of the rear extension table's legs can be adjusted as needed to level the table.

Pre-installation



Aligning the bracket

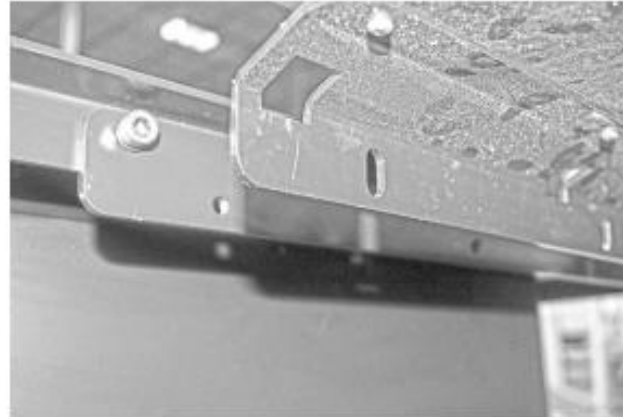



Bolt into thread holes:



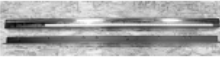

Front Rail Pt. 2 & Control Switch-

The Fusion F3 table saw's front rail houses the control switch and front rail/guide ruler. The control switch allows the user to quickly turn the machine on/off before and after making cuts. The front rail assembly provides the user with a guide to measure the distance between the fence and the blade.

Quick Reference Guide	
	
Add. Required Tools: <ul style="list-style-type: none"> • Level • General Wrench • 13mm socket wrench (optional) 	
Troubleshooting/Tips: Be sure to attach the control switch to the left front rail from underneath the front left rail bracket. This will allow the left front rail block to fit properly on the left front rail bracket..	

Parts			
REF	Description	Q	Installation
	Front Rail Assembly (Rails previously assembled, body is needed)	1	Body mounted to rail
	Left Side Front Body (Rails previously assembled, body is needed)	1	F3 Table Rail Body
	Control Switch	1	Bolts onto Left side Rail

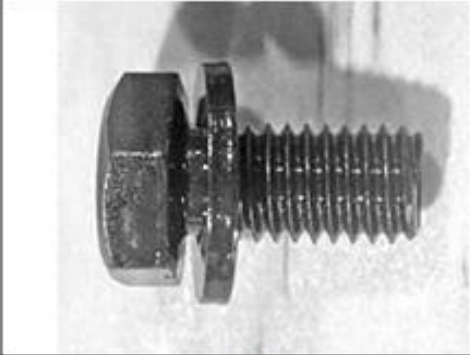
Hardware			
REF	Description	Q	Installation
C	Hex Cap Screw w/ Flat Washer (longer)	2 of 5	Control Switch, Left Front Rail

Hardware			
			
	Hex Cap Screw w/ Flat Washer (shorter)	9 of 9	Front Body to Front Rail (left & right side)

Mounting the Control Switch to the Left Front Rail (Cont'd.):

- 1.) Align the bolt holes on the top of the control switch with the bolt holes on the bottom of the left front rail bracket.
- 2.) Thread the 2 longer hex cap screw and flat washer through the control switch's bolt holes.
- 3.) Tighten the bolts using either the general wrench or a 13 mm socket wrench to secure the control switch to the left front rail bracket.

TECH TIP Ensure that the head of the hex bolts are threaded from underneath the left front rail. The ends of each the bolts should be visible from the top of the left front rail.

Pre-Installation:



Control Switch Placement:

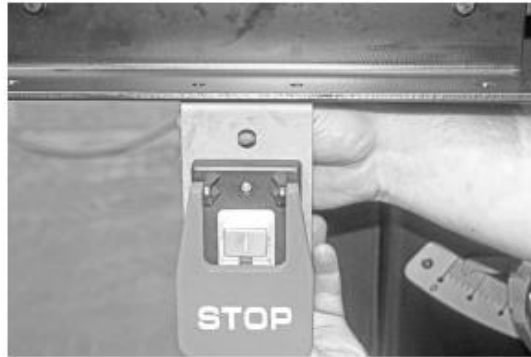

Mounting Control Switch with 2 longer hex bolts and flat washers



Control Switch correctly mounted. The expose bolts will fit the through holes in the fence body



Mounting the Left Front Rail Block to the Left Front Rail:

- 1.) Place the left front rail block on the left front rail bracket.
- 2.) Align the block's outermost through holes with the bracket's outermost through holes.
- 3.) Like mounting the control switch, thread the shorter hex bolts with flat washers from underneath the left front rail bracket.
- 4.) Using either the general wrench or a socket wrench, tighten the bolts to secure the left front rail block to the left front rail bracket.

Pre-Installation



Attaching the left front rail body to the left front rail using the shorter hex bolts and flat washers.



Mounting the Front Rail (with Guide Ruler):

1. Place the front rail on the front rail bracket.
2. Align the front rail's bolt holes (located on the bottom of the front rail) with the front rail's bolt holes.
3. Thread shorter hex bolts with flat washer through each of the front rail's bolt holes.

TECH TIP Only hand-tighten the bolts for now.

4. Pull the rail out as far as it will allow first. This will allow space for the fence's nylon slider to move through comfortably.
5. Tighten each bolt using either the general wrench or a 13 mm socket wrench.

Front guide rail seated on front rail:

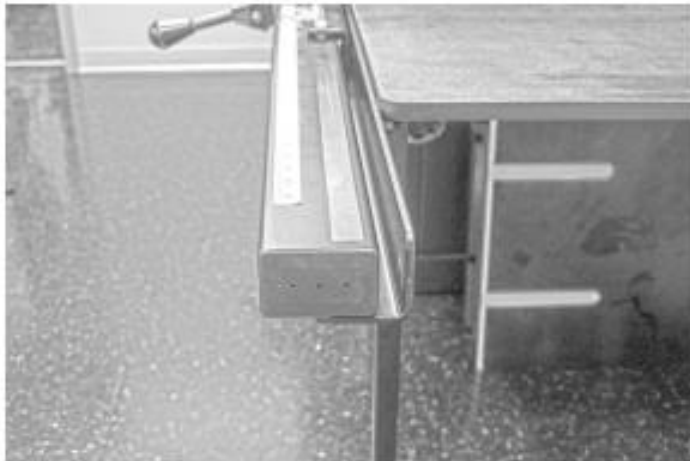

Underside View



Fitting the Fence to the Table:

TECH TIP

The table saw's fence comes pre-assembled and will need no further assembly to put the unit together.

- 1.) Place the fence's nylon sliders on the grooves between the front and back rails.
- 2.) Ensure that the fence's locking gauge is placed over the edge of the front rail.

Fence fitted over the front guide rail



Detailed view

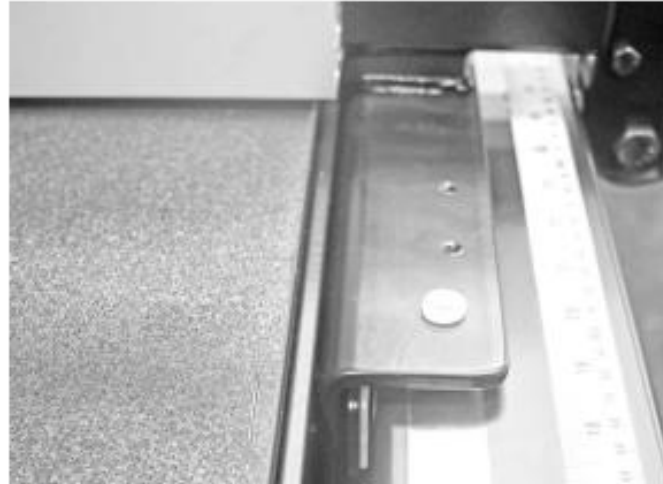

Front of rail showing counter sunk screws



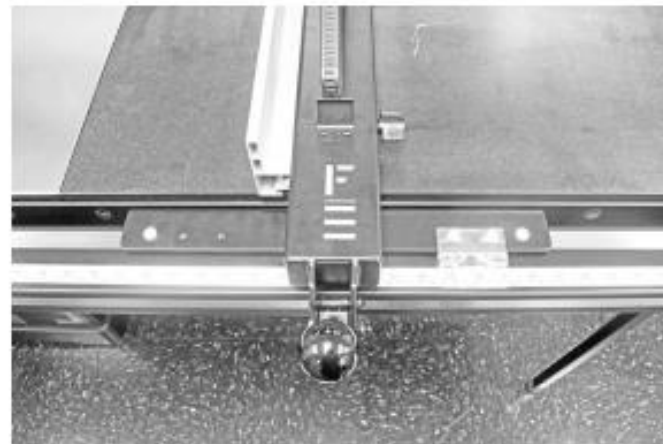

Properly Installed Fence:



Accessory Installation-

The Fusion F3 table saw's supports several accessories which help the machine to run smoothly and function properly. The accessories which come with your table saw are a dust collector hose, a set of fence hooks, and a tool caddy (located underneath the table).

Quick Reference Guide

Add. Required Tools: <ul style="list-style-type: none"> • None
Troubleshooting/Tips: The writhing knife can be found already attached to the blade upon arrival. Be sure the machine is off, when you attempt to remove the writing knife from its position on the back of the blade.

Parts			
REF	Description	Q	Installation
	Blade Guard Assembly	1	Boxed Individually
	Dust Collection Hose	1	Blade-guard to Inlet

You will also need all the contents in the packages of:

Band clamp with hex bolt, flat washer, and hex nut. Fence hooks and hex bolts with flat washers.



Attaching the Dust Collector Hose:

- 1.) Attach a band clamp on the mouth of the dust collector hose.
- 2.) Attach the hose to the dust port on the blade guard.
- 3.) Tighten the band clamp to secure the hose to the blade guard.
- 4.) Repeat steps one through three to attach the hose to the table saw's 4" dust outlet.

Attaching hose to blade guard assembly:

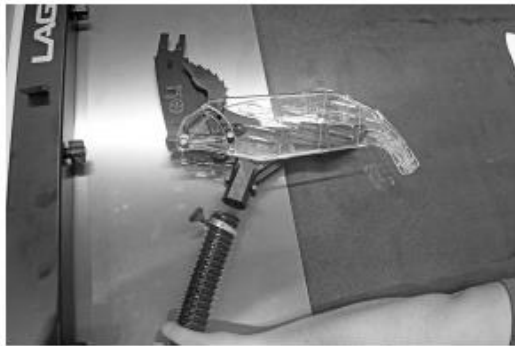

Attaching hose to dust port:

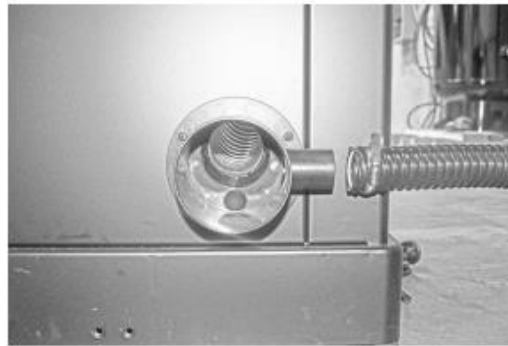

Attaching the Fence Hooks to the Table:

- 1.) Locate the fence hook bolt holes on the back of the table saw (located underneath the rear extension table).
- 2.) Thread the fence hook's hex bolts through the fence hook's bolt holes.
- 3.) Thread the hex bolts through the bolt's holes on the back of the table saw.
- 4.) Tighten the hex bolts with the general wrench.

Fence Hook Installation



Fence Hook Installation



Tool Caddy:

The table saw's tool caddy is located under the right extension table. The tool caddy provides a space to store the miter gauge, the writing knife, and the blade wrench, and the general wrench when not in use. See the picture shown below to see proper placement of these tools.

From Top Down:

- A.) Arbor Wrench.
- B.) Miter Gauge.
- C.) Riving Knife.
- D.) Blade Guard Hook.
- E.) Dust Hose Wrapping Hook.

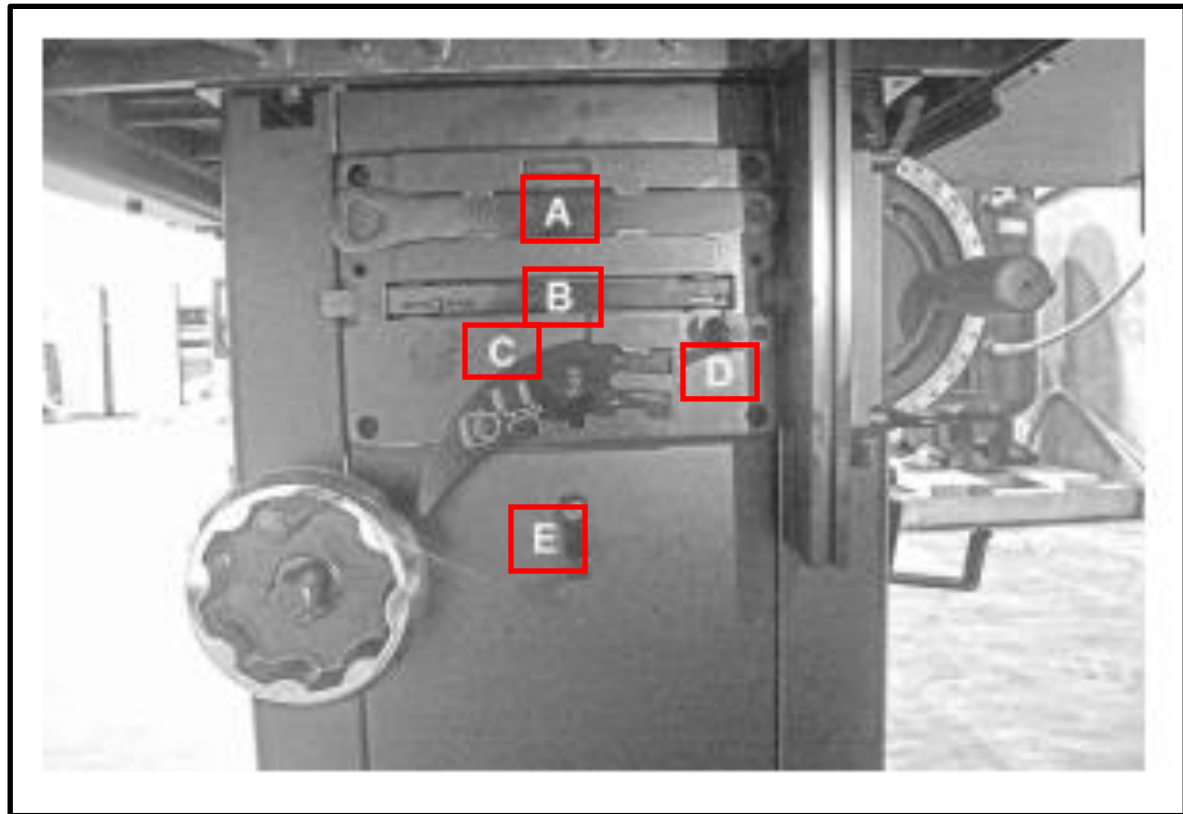

SOP to for the Preset Trunnion Bolts Fusion 3 Table Saw- (*Optional) These Bolts are usually Set at the Factory; This information is optional to help instruct customer set Blade at 90 Degrees, if needed.

Step 1

Make sure the Blade at 90 °.

Adjust Left Side Hex Screw to contact with Limit Plate.

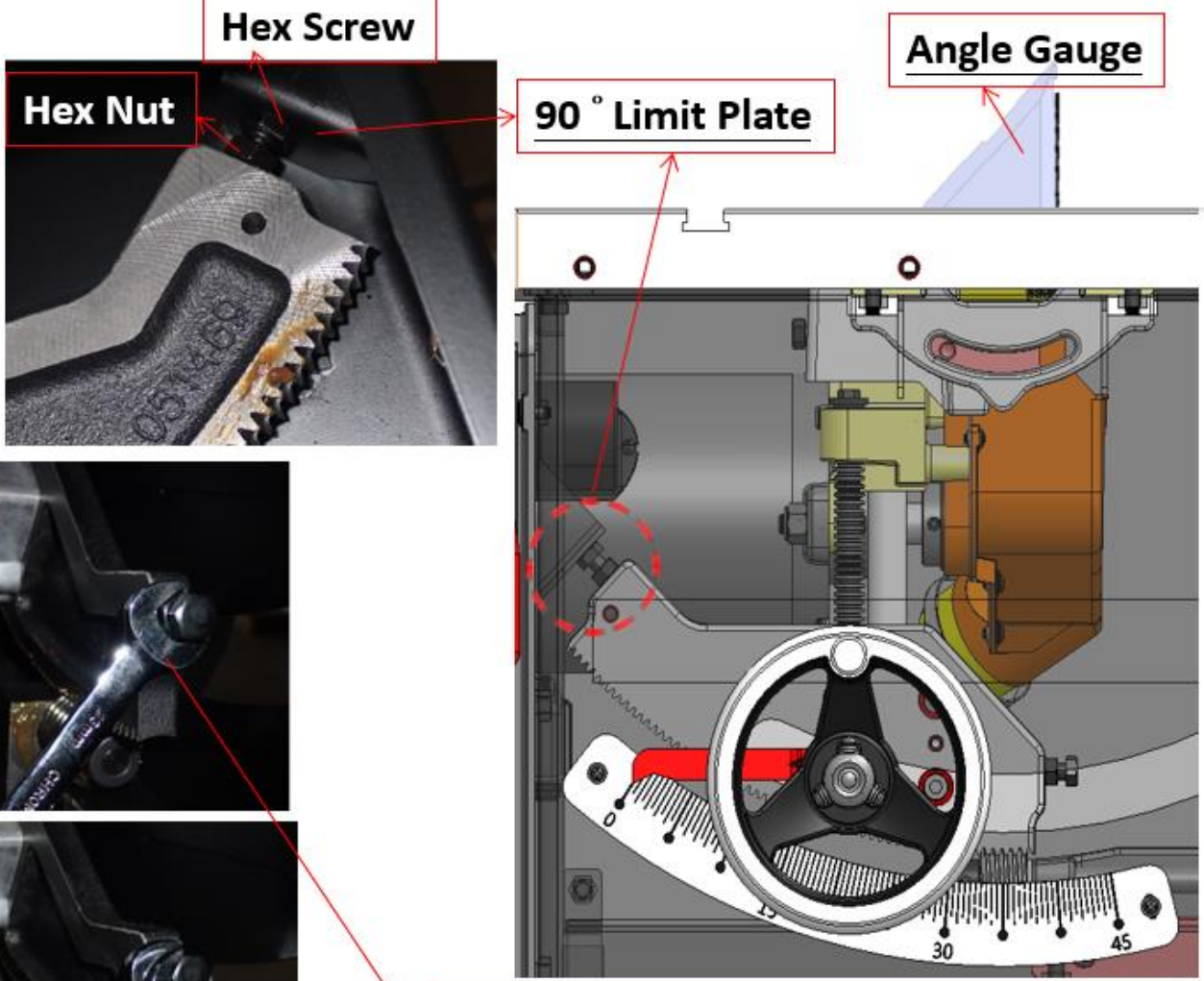

Step 2
Holt the Hex Screw then tighten the Hex Nut.

SOP to for the Preset Trunnion Bolts Fusion 3 Table Saw (Cont'd.)-

Step 1

Make sure the Blade at 45 °
Adjust right side Hex Screw to contact
with Limit Plate.

Angle Gauge

45 ° Limit Plate

Hex Screw

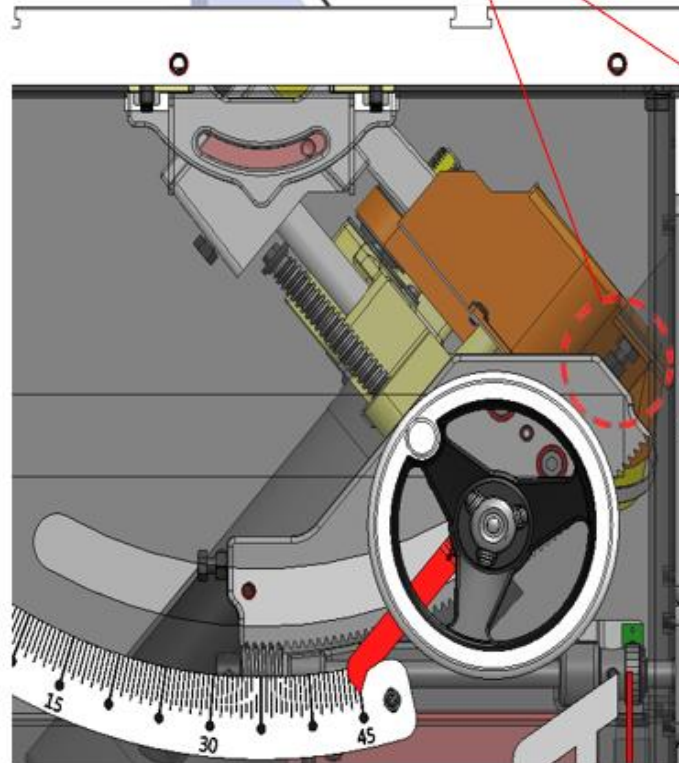

Hex Nut



Step 2

Holt the Hex Screw, then tighten the Hex Nut.

SOP to Align Table to Blade on Fusion 3 Table Saw-

Align Table to the Blade F3

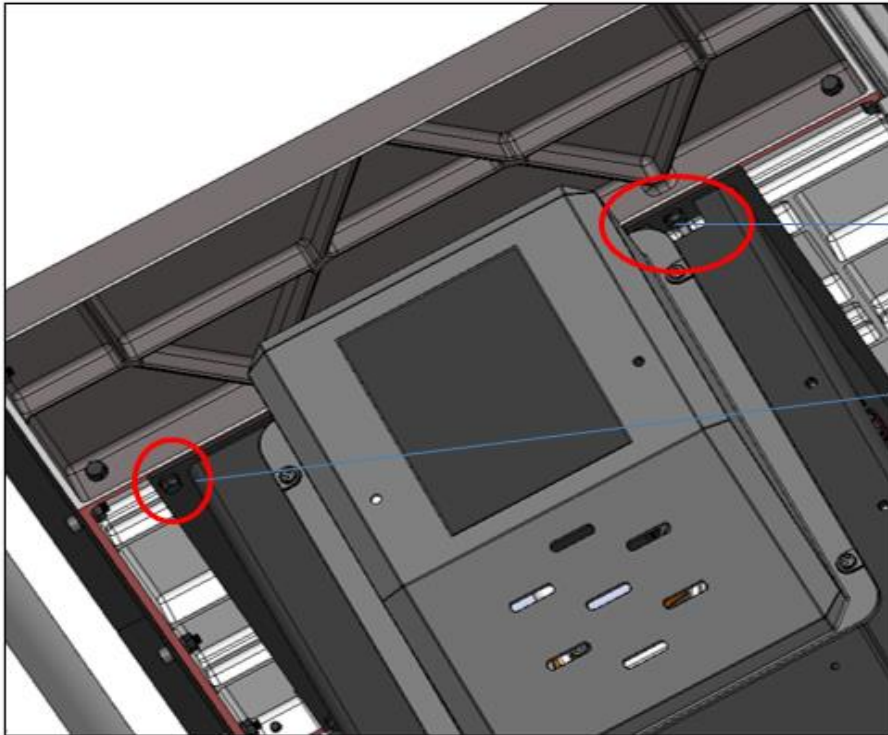

STEP1: Loosen 4 Screws as shown.

STEP2: Adjust Table to make the T-Slot Parallel to Saw Blade.
STEP3: Tighten 4 Screws.

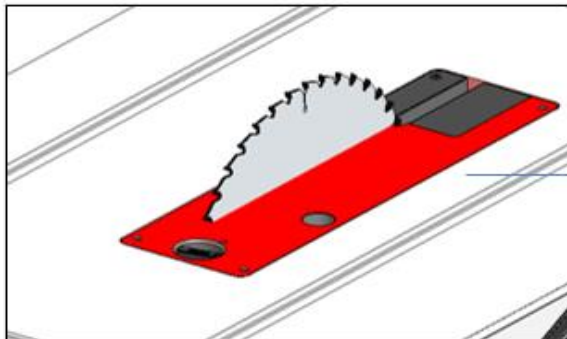

T-SLOT

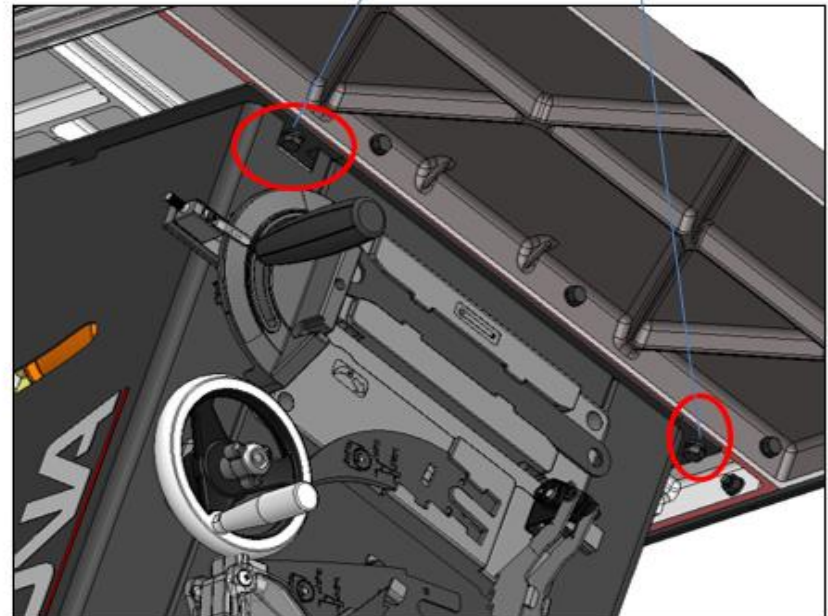

DRO (Digital Read-Out) Calibration-



The **Fusion 3** come standard with a digital read out (**DRO**). If the **DRO** every comes out of calibration please use the following guide to reset.

Step 1.) Tilt the scale to 0°, Press ZERO to Reset , display 0.0.

Step 2.) Bevel to 45°, Press & Hold SET.

Step 3.) While holding SET press and hold ZERO for 3 seconds. The **DRO** will display 45.0 after the release of ZERO. Release Set.

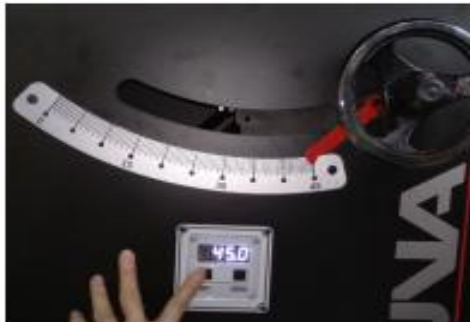
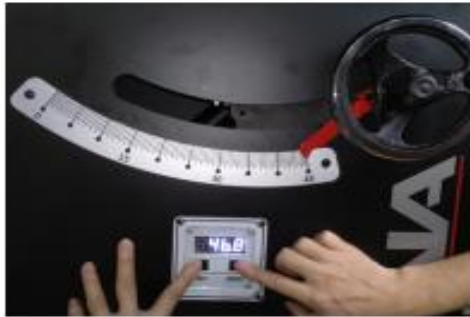

DRO (Digital Read-Out) Trouble Shooting-

If you are experiencing problems with the DRO not powering on, please follow this guide.

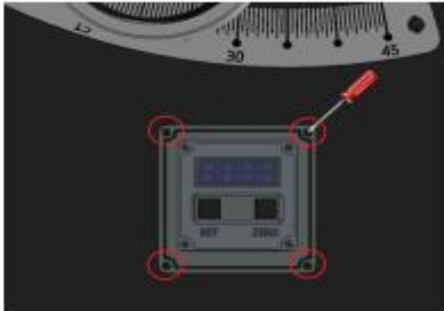

Step 1.) Turn off power and unplug table saw, then remove **DRO** display cover.



Step 2.) Pull out the circuit board, check the black and white cords connection.

Step 3.) If multi-meter is available, please re-plug table saw, and check voltage between black and white cords.

Step 4.) If circuit board is checked **“OK”**, please check contactor box.

Step 5.) The contactor box is inside the cabinet, remove the cover.

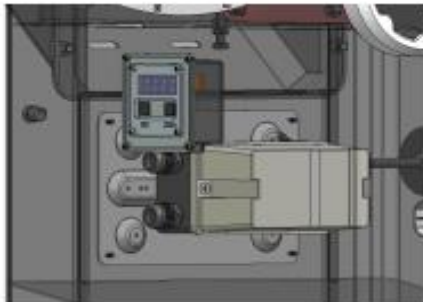

Step 6.) Check L1 & L3 connection.



Maintenance-

⚠ WARNING! Never perform and setup, maintenance or adjustment procedures with the machine connected to the power source!

⚠ WARNING! If you have any doubt about the described procedure, seek professional assistance. Do not attempt any procedure that you feel is unsafe, or that you do not have the physical capability of achieving.

⚠ WARNING! When removing banding, extreme caution must be used as the banding will spring when cut.

⚠ CAUTION! The machine is heavy. Ensure that you have enough people to do the job safely.

🔧 TECH TIP There may be sawdust in or around your new machine as a result of thorough testing.

General

Keep your machine clean. At the end of each day, clean the machine. Wood contains moisture, and if sawdust or wood chips are not removed, they will cause rust. In general, we recommend that you only use a Teflon-based lubricant on the saw. Regular oil attracts dust and dirt. Teflon lubricant tends to dry and has less of a tendency to accumulate dirt and saw dust. Periodically check that all nuts and bolts are tight.

Drive belt

The drive belt should last for many years (depending on the usage) but needs to be inspected regularly for cracks, cuts and general wear. If damage is found, replace the belt.

Bearings

All bearings are sealed for life and do not require any maintenance. If a bearing becomes faulty, replace it.

Rust

The saw is made from steel and cast iron. All non-painted surfaces will rust if not protected. It is recommended that they be protected by applying wax or a Teflon- based lubricant to them.

Daily Check:

- Loose mounting bolts
- Damaged saw blade
- Damaged riving knives, splitters, or blade guards
- Worn or damaged wires
- Any other unsafe condition

Monthly Maintenance:

- Clean/vacuum dust buildup from inside cabinet and off motors.
- Check/replace belt for proper tension, damage or wear

Weekly Maintenance:

- Clean table surface and miter slot grooves
- Clean and protect cast iron table
- Clean rip fence

Every 6–12 Months:

- Lubricate trunnion slides.
- Lubricate worm gear.
- Lubricate leadscrew.
- Lubricate gearing and gearboxes.

Troubleshooting-

Behavior	Possible Causes	Solutions
Machine will not start or continues to trip the breaker.	1.) Start capacitor at fault. 2.) Motor connection wired wrong. 3.) Wiring at fault. 4.) Motor Start/Stop switch at fault. 5.) Motor at fault. 6.) Run capacitor at fault. 7.) Wall circuit breaker tripped or at fault. 8.) Power supply switched OFF or at fault. 9.) Plug/receptacle at fault or wired incorrectly.	1.) Test/replace if faulty. 2.) Correct motor wiring connections. 3.) Check/fix broken, disconnected, or corroded wires. 4.) Replace switch. 5.) Test/repair/replace. 6.) Test/replace if faulty. 7. Ensure circuit size is correct/replace weak breaker. 8.) Ensure power supply is on/has correct voltage.
Machine is excessively loud or is experiencing excessive vibration.	1.) Motor or component loose. 2.) Blade at fault. 3.) Motor mount loose/broken. 4.) Machine incorrectly mounted. 5.) Arbor pulley loose. 6.) Belts worn or loose. 7.) Pulley loose or at fault. 8.) Arbor bearings at fault	1.) Inspect/replace damaged bolts/nuts, and retighten with thread-locking fluid. 2.) Replace warped/bent blade; re-sharpen dull blade. 3.) Tighten/replace. 4.) Tighten mounting bolts; relocate/shim machine. 5.) Re-tighten/replace arbor pulley. 6.) Adjust tension off/replace belt. 7.) Realign/replace shaft, pulley, setscrew, and key. 8a.) Replace arbor housing bearings; replace arbor. 8b.) Test by rotating shaft; grinding/loose shaft requires bearing replacement.
Machine trips the overload, or feels underpowered during operation.	1.) Feed rate/cutting speed too fast. 2.) Workpiece material unsuitable for machine. 3.) Pulley/sprocket slipping on shaft. 4.) Motor bearings at fault. 5.) Contactor (internal breaker) at fault. 6.) Motor overheated. 7.) Workpiece crooked; fence not aligned. 8.) Machine undersized for task; wrong blade. 9.) Run capacitor at fault. 10.) Belt is slipping from pulley. 11.) Motor wired incorrectly. 12.) Plug/receptacle at fault. 13.) Motor at fault.	1.) Decrease feed rate/cutting speed. 2.) Only cut wood; ensure moisture is below 20%. 3.) Test for good contacts/correct wiring. 4.) Replace loose pulley/shaft. 5.) Test/repair/replace. 6.) Test all legs for power/replace if faulty. 7.) Clean motor, let cool, and reduce workload. 8.) Straighten or replace workpiece; adjust fence. 9.) Use correct blade; reduce feed rate or depth of cut. 10.) Test/repair/replace. 11.) Adjust tension off/replace belt. 12.) Wire motor correctly. 13.) Test/repair/replace.
Dust Collection	1.) Inadequate suction 2.) No Suction	1.) Check Dust Collection Unit and hose fittings. 2.) move motor cover and verify that the internal hose is fixed to the blade shroud port and the external 4" port.

Specifications-

	FUSION F1	FUSION F2	FUSION F3	FUSION F3 52
Condensed Specs				
Maximum Blade Diameter	10" (254 mm)	10" (254 mm)	10" (254 mm)	10" (254 mm)
Max Rip Right of Blade w/Included Fence & Rails	31" (787.4 mm)	37" (940 mm)	37" (940 mm)	53" (1346.2 mm)
Fence Type	Camlock T-Shape w/Aluminium Face	Camlock T-Shape w/European Hi-Lo Face	Camlock T-Shape w/European Hi-Lo Face	Camlock T-Shape w/European Hi-Lo Face
Table	Precision-Ground Cast Iron	Precision-Ground Cast Iron	Precision-Ground Cast Iron	Precision-Ground Cast Iron
Wings	Pre-Formed Steel	Precision-Ground Cast Iron	Precision-Ground Cast Iron	Precision-Ground Cast Iron
Cabinet	Pre-Formed Steel	Pre-Formed Steel	14 Ga. Steel	14 Ga. Steel
Trunnions	Cast Alloy	Cast Alloy	Cast Iron	Cast Iron
Dust Port Size	4" (101.6 mm)	4" (101.6 mm)	4" (101.6 mm)	4" (101.6 mm)
Blade Guard Dust Port Size	1-1/2" (38.1 mm)	1-1/2" in. (38.1 mm)	1-1/2" (38.1 mm)	1-1/2" (38.1 mm)
Weight, Gross	214 Lbs (97 Kg)	359 Lbs (163 Kg)	482 Lbs (219 Kg)	533.58 Lbs (242 Kg)
Weight, Net	195 Lbs (88.5 Kg)	276 Lbs (124.6 Kg)	385 Lbs (175 Kg)	405 Lbs (184 Kg)
Overall Width (side-to-side)	58-3/4" (1494 mm)	66-3/4" (1697 mm)	68-7/8" (1751 mm)	85" (2157.47 mm)
Overall Depth (front-to-back)	37-1/4" (945 mm)	39-3/8" (1000 mm)	56" (1425 mm)	56" (1425 mm)
Overall Height	42-1/2" (1080 mm)	42-7/8" (1090 mm)	42-7/8" (1090 mm)	42-7/8" (1090 mm)
Power Requirement	110V, Single-Phase, 60 Hz	110V, Single-Phase, 60 Hz	220V, Single-Phase, 60 Hz	220V, Single-Phase, 60 Hz
Horsepower	1.5HP	1.75HP	3HP	3HP
Country of Origin	Taiwan	Taiwan	Taiwan	Taiwan
Certified by a Nationally Recognized Testing Laboratory (NRTL)	Yes	Yes	Yes	Yes
	F1 Features	F2 Features	F3 Features	F3 52 Features
	Fusion Hi-Lo Dust Collection	Full Cabinet Body	Industrial 14 Gauge (2mm) Cabinet	52" Rip Capacity
	Fusion Over-Under Trunnions	Cabinet Mounted Arbor	Accessory Tables (Outfeed & Rip)	Industrial 14 Gauge (2mm) Cabinet
	Polished Cast Iron Table	Cast Iron Table & Wings	Industrial Fence Rail	Accessory Tables (Outfeed & Rip)
	Reset Switch	European Hi-Lo Fence	Industrial Fusion Fence	Industrial Fence Rail
	Quick-Release Blade Guard and Spreader	Premium Zero Clearance Throat Plate	Premium Electrical & Hardware Components	Industrial Fusion Fence
	Riving Knife Included	Fusion Hi-Lo Dust Collection	Premium Mitre Gauge	Premium Electrical & Hardware Components
	Push Stick included	Fusion Over-Under Trunnions	Cast Iron Fusion Trunnions	Premium Mitre Gauge
	Mitre Gauge Included	Reset Switch	Cabinet Mounted Arbor	Cast Iron Fusion Trunnions
	Blade Changing Tool Included	Quick-Release Blade Guard and Spreader	Cast Iron Table & Wings	Cabinet Mounted Arbor
	Integrated Tool Storage	Riving Knife Included	European Hi-Lo Fence	Cast Iron Table & Wings

Specifications (Cont'd.)-

	FUSION F1	FUSION F2	FUSION F3	FUSION F3 52
	Premium Handles	Push Stick included	Premium Zero Clearance Throat Plate	European Hi-Lo Fence
	Included 10 x 60T Carbide-Tipped Blade	Mitre Gauge Included	Fusion Hi-Lo Dust Collection	Premium Zero Clearance Throat Plate
	Premium Arbor and Motor Bearings	Blade Changing Tool Included	Magnetic Contactor Switch	Fusion Hi-Lo Dust Collection
		Integrated Tool Storage	Quick-Release Blade Guard and Spreader	Magnetic Contactor Switch
		Premium Handles	Riving Knife Included	Quick-Release Blade Guard and Spreader
		Included 10 x 60T Carbide-Tipped Blade	Push Stick included	Riving Knife Included
		Premium Arbor and Motor Bearings	Mitre Gauge Included	Push Stick included
			Blade Changing Tool Included	Mitre Gauge Included
			Integrated Tool Storage	Blade Changing Tool Included
			Included 10 x 60T Carbide-Tipped Blade	Integrated Tool Storage
			Premium Arbor and Motor Bearings	Included 10 x 60T Carbide-Tipped Blade
				Premium Arbor and Motor Bearings
Main Information				
Table Saw Type	Hybrid Cabinet	Cabinet	Cabinet	Cabinet
Maximum Blade Diameter	10 in. (254 mm)	10 in. (254 mm)	10 in. (254 mm)	10 in. (254 mm)
Arbor Size	5/8" (15.87 mm)	5/8" (15.87 mm)	5/8" (15.87 mm)	5/8" (15.87 mm)
Arbor Speed	4000 RPM	4500 RPM	4500 RPM	4500 RPM
Maximum Width of Dado	3/4" (19.05 mm)	3/4" (19.05 mm)	3/4" (19.05 mm)	3/4" (19.05 mm)
Blade Tilt Direction	Left	Left	Left	Left
Max Blade Tilt	45 deg.	45 Degrees	45 Degrees	45 Degrees
Maximum Depth of Cut At 90 Degrees	3-1/8" (79.37 mm)	3-1/8" (79.37 mm)	3-1/8" (79.37 mm)	3-1/8" (79.37 mm)
Maximum Depth of Cut At 45 Degrees	2-1/8" (53.97 mm)	2-1/8" (53.97 mm)	2-1/8" (53.97 mm)	2-1/8" (53.97 mm)
Max Rip Right of Blade w/Included Fence & Rails	31" (787.4 mm)	37"(940 mm)	37" (940 mm)	53" (1346.2 mm)
Max Rip Left of Blade w/Included Fence & Rails	19-5/8" (500 mm)	19-5/8" (500 mm)	19-5/8" (500 mm)	19-5/8" (500 mm)
Additional Blade Information				
Included Blade Information	10" x 60T	10" x 60T	10" x 60T	10" x 60T
Riving Knife/Spreader Thickness	3/32" (2.28 mm)	3/32" (2.28 mm)	3/32" (2.28 mm)	3/32" (2.28 mm)
Required Blade Body Thickness	>3.0mm	>3.0mm	>3.0mm	>3.0mm
Required Blade Kerf Thickness	<2.0mm	<2.0mm	<2.0mm	<2.0mm

Specifications (Cont'd.)-

	FUSION F1	FUSION F2	FUSION F3	FUSION F3 52
Table Information				
Floor to Table Height	34-3/8" (873 mm)	34-7/8" (886.5 mm)	34-7/8" (886.5 mm)	34-7/8" (886.5 mm)
Table Size with Extension Wings Width	44" (1118 mm)	44" (1118 mm)	60" (1547 mm)	76-7/8" (1953.514 mm)
Table Size with Extension Wings Depth	27" (686 mm)	27" (686 mm)	30" (683.5 mm)	30" (683.5 mm)
Distance Front of Table to Center of Blade	13-1/2" (342 mm)	13-3/8" (340 mm)	13-1/2" (342 mm)	13-1/2" (342 mm)
Distance Front of Table to Blade At Maximum Cut	8-5/8" (220 mm)	8-5/8" (220 mm)	8-5/8" (220 mm)	8-5/8" (220 mm)
Main Table Size Thickness	1-1/2" (38 mm)	1-1/2" (38 mm)	1-1/2" (38 mm)	1-1/2" (38 mm)
Fence Information				
Fence Type	Camlock T-Shape w/Aluminium Face	Camlock T-Shape w/European Hi-Lo Face	Camlock T-Shape w/European Hi-Lo Face	Camlock T-Shape w/European Hi-Lo Face
Fence Size Length	33-1/2" (850 mm)	33-1/2" (850 mm)	33-1/2" (850 mm)	33-1/2" (850 mm)
Fence Size Width	9-7/8" (250 mm)	9-7/8" (250 mm)	9-7/8" (250 mm)	9-7/8" (250 mm)
Fence Size Height	2-1/2" (62 mm)	3" (77 mm)	3" (77 mm)	3" (77 mm)
Fence Rail Type	Aluminium Extrusion/Angle Steel	Aluminium Extrusion/Angle Steel	Steel/Angle Steel	Steel/Angle Steel
Fence Rail Length	59-3/8" (1508 mm)	66-5/8" (1691 mm)	67-7/8" (1724 mm)	67-7/8" (1724 mm)
Fence Rail Width	2-7/8" (74.2 mm)	2-7/8" (74.2 mm)	3" (76.2 mm)	3" (76.2 mm)
Fence Rail Height	2" (50.8 mm)	2" (50.8 mm)	2" (50.8 mm)	2" (50.8 mm)
Mitre Gauge Information				
Mitre Gauge Slot Type	T-Slot	T-Slot	T-Slot	T-Slot
Mitre Gauge Slot Size Width	3/4" (19 mm)	3/4" (19 mm)	3/4" (19 mm)	3/4" (19 mm)
Mitre Gauge Slot Size Height	3/8" (9.8 mm)	3/8" (9.8 mm)	3/8" (9.8 mm)	3/8" (9.8 mm)
Construction				
Table	Precision-Ground Cast Iron	Precision-Ground Cast Iron	Precision-Ground Cast Iron	Precision-Ground Cast Iron
Wings	Pre-Formed Steel	Precision-Ground Cast Iron	Precision-Ground Cast Iron	Precision-Ground Cast Iron
Cabinet	Pre-Formed Steel	Pre-Formed Steel	14 Ga. Steel	14 Ga. Steel
Trunnions	Cast Alloy	Cast Alloy	Cast Iron	Cast Iron
Body Assembly	Pre-Formed Steel	Pre-Formed Steel	14 Ga. Steel	14 Ga. Steel
Fence Assembly	Aluminium Extruded Body	Aluminium Extruded Body	Steel Body	Steel Body
Rails	Steel	Steel	Industrial Steel	Industrial Steel
Mitre Gauge Construction	Aluminium Body with Steel Bar	Aluminium Body with Steel Bar	Cast Iron with Steel Bar, Alu Fence	Cast Iron with Steel Bar, Alu Fence
Guard	Steel and Clear Plastic	Steel and Clear Plastic	Steel and Clear Plastic	Steel and Clear Plastic
Body/Cabinet Paint Type/Finish	Powder Coated	Powder Coated	Powder Coated	Powder Coated
Arbor Bearings	Sealed & Permanently Lubricated	Sealed & Permanently Lubricated	Sealed & Permanently Lubricated	Sealed & Permanently Lubricated

Specifications (Cont'd.)-

	FUSION F1	FUSION F2	FUSION F3	FUSION F3 52
Other Related Information				
Number of Dust Ports	1.00	1.00	1.00	1.00
Dust Port Size	4" (101.6 mm)	4" (101.6 mm)	4" (101.6 mm)	4" (101.6 mm)
Compatible Mobile Base	YES	Integrated	Integrated	Integrated
Blade Guard Dust Port Size	1-1/2" (38.1 mm)	1-1/2" (38.1 mm)	1-1/2" (38.1 mm)	1-1/2" (38.1 mm)
Dust Collection CFM Requirement	400 CFM	400 CFM	400 CFM	400 CFM
Dust Collection Static Pressure	5" H20	5" H20	5" H20	5" H20
Product Dimensions				
Weight, Gross	214 Lbs (97 Kg)	359 Lbs (163 Kg)	482 Lbs (219 Kg)	533.58 Lbs (242 Kg)
Weight, Net	195 Lbs (88.5 Kg)	276 Lbs (124.6 Kg)	385 Lbs (175 Kg)	405 Lbs (184 Kg)
Overall Width (side-to-side)	58-3/4" (1494 mm)	66-3/4" (1697 mm)	68-7/8" (1751 mm)	84-7/8" (2157.47 mm)
Overall Depth (front-to-back)	37-1/4" (945 mm)	39-3/8" (1000 mm)	56-1/8" (1425 mm)	56-1/8" (1425 mm)
Overall Height	42-1/2" (1080 mm)	42-7/8" (1090 mm)	42-7/8" (1090 mm)	42-7/8" (1090 mm)
Footprint Width	20-1/2" (520.6 mm)	19-1/4" (490 mm)	20-1/2" (520 mm)	48" (1219.2 mm)
Footprint Length	20-5/8" (525 mm)	18-5/8" (473 mm)	42-1/2" (1080 mm)	42-1/2" (1080 mm)
Space Required for Full Range of Movement Width (side-to-side)	58-3/4" (1494 mm)	66-3/4" (1697 mm)	68-7/8" (1751 mm)	85" (2157.47 mm)
Space Required for Full Range of Movement Depth (front-to-back)	37-1/4" (945 mm)	39-3/8" (1000 mm)	56-1/8" (1425 mm)	56-1/8" (1425 mm)
Shipping Dimensions				
Carton Number	1.00	1.00	1.00	1.00
Carton Type	Box	Wood Crate	Wood Crate	Wood Crate
Content	Everything	Everything	Everything	Table saw
Weight, Gross	214 Lbs (97 Kg)	359 lbs. (163 Kg)	482 lbs. (219 Kg)	482 lbs. (219 Kg)
Length	42-3/8" (1075 mm)	49-1/4" (1250 mm)	57" (1450 mm)	51-1/8" (1300 mm)
Width	26-3/4" (680 mm)	29-7/8" (760 mm)	29-7/8" (760 mm)	29-7/8" (760 mm)
Height	25-5/8" (650 mm)	42-3/4" (1085 mm)	42-3/4" (1085 mm)	42-3/4" (1085 mm)
Must Ship Upright	YES	YES	YES	YES
Carton Number				2.00
Carton Type				Wood Crate
Content				52" Fence Rails
Weight, Gross				51.58 Lbs (23.4 Kg)
Length				69-3/4" (1775 mm)
Width				4-1/8" (105 mm)
Height				3-7/8" (100 mm)
Must Ship Upright				YES

Specifications (Cont'd.)-

	FUSION F1	FUSION F2	FUSION F3	FUSION F3 52
ELECTRICAL				
Power Requirement	110V, Single-Phase, 60 Hz	110V, Single-Phase, 60 Hz	220V, Single-Phase, 60 Hz	220V, Single-Phase, 60 Hz
Prewired Voltage	110V	110V	220V	220V
Full-Load Current Rating	13A	14A	15A	15A
Minimum Circuit Size	20A	25A	25A	25A
Connection Type	Cord & Plug	Cord & Plug	Cord & Plug	Cord & Plug
Power Cord Included	Yes	Yes	Yes	Yes
Power Cord Length	6 ft.	6 ft.	6 ft.	6 ft.
Power Cord Gauge	14 AWG	14 AWG	14 AWG	14 AWG
Plug Included	Yes	Yes	Yes	Yes
Included Plug Type	5-15	5-15	6-15	6-15
Switch Type	ON/OFF Push Button Switch w/Large Shut-Off Paddle & Padlock	ON/OFF Push Button Switch w/Large Shut-Off Paddle & Padlock	ON/OFF Push Button Switch w/Large Shut-Off Paddle & Padlock, Additional Magnetic Contactor in line	ON/OFF Push Button Switch w/Large Shut-Off Paddle & Padlock, Additional Magnetic Contactor in line
MOTOR				
Use	Main	Main	Main	Main
Horsepower	1.5HP	1.75HP	3HP	3HP
Phase	Single-Phase	Single-Phase	Single-Phase	Single-Phase
Amps	13A	14A	15A (220V)	15A (220V)
Speed	3600 RPM	3450 RPM	3450 RPM	3450 RPM
Type	TEFC Capacitor-Start Induction	TEFC Capacitor-Start Induction	TEFC Capacitor-Start Induction	TEFC Capacitor-Start Induction
Power Transfer	Poly-V Belt Drive	Poly-V Belt Drive	Poly-V Belt Drive	Poly-V Belt Drive
Bearings	Sealed & Permanently Lubricated	Sealed & Permanently Lubricated	Sealed & Permanently Lubricated	Sealed & Permanently Lubricated
OTHER SPECIFICATIONS				
Country of Origin	Taiwan	Taiwan	Taiwan	Taiwan
Warranty	1 Year	1 Year	1 Year	1 Year
Approximate Assembly & Setup Time	1 Hour	1 Hour	1 Hour	1 Hour
Serial Number Location	ID label on cabinet	ID label on cabinet	ID label on cabinet	ID label on cabinet
Sound Rating	60-78 DBa	60-78 DBa	60-78 DBa	60-78 DBa
ISO 9001 Factory	Yes	Yes	Yes	Yes
Certified by a Nationally Recognized Testing Laboratory (NRTL)	Yes	Yes	Yes	Yes

Wiring Diagram-

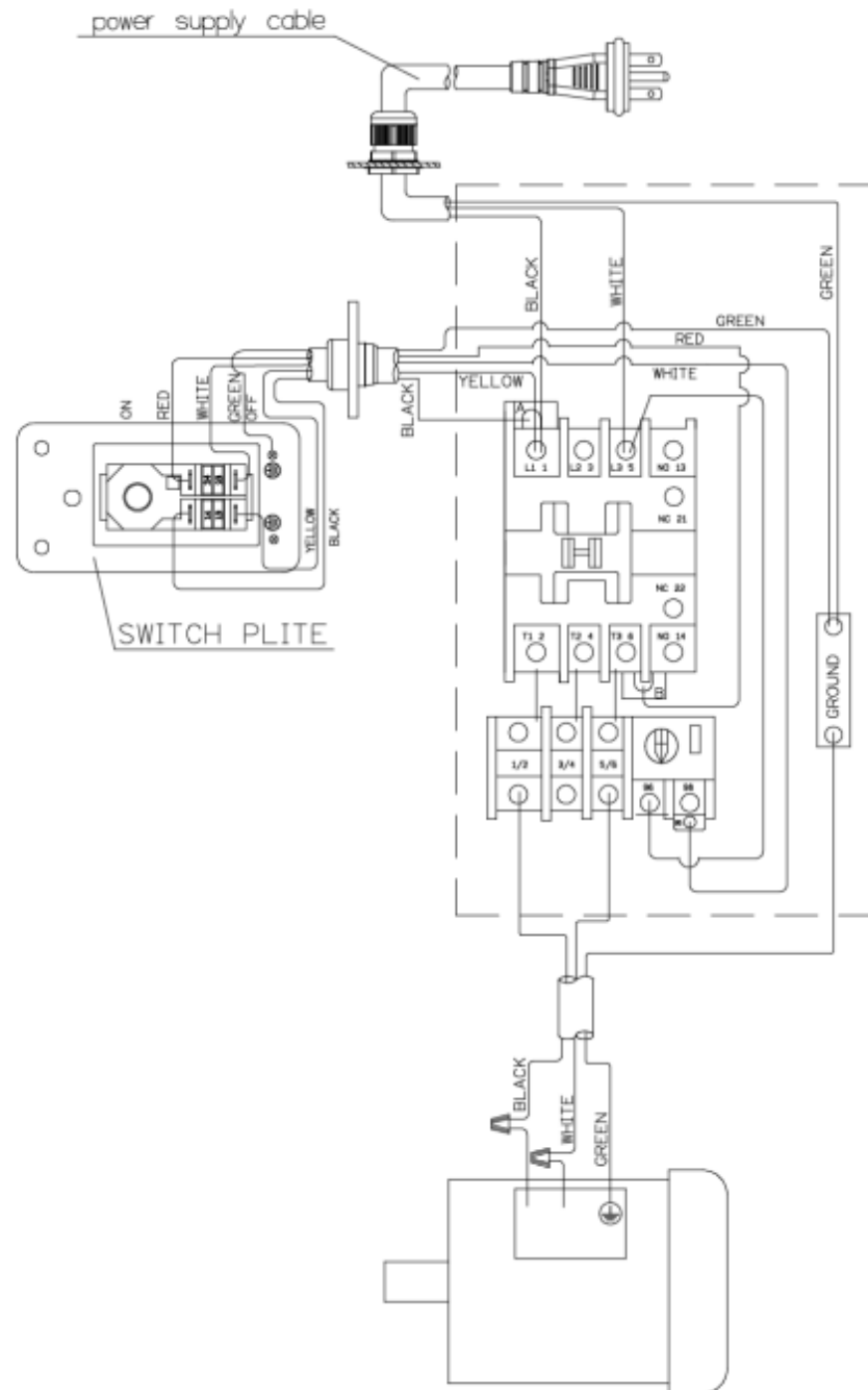

Replacement Parts Diagram-

Cabinet-

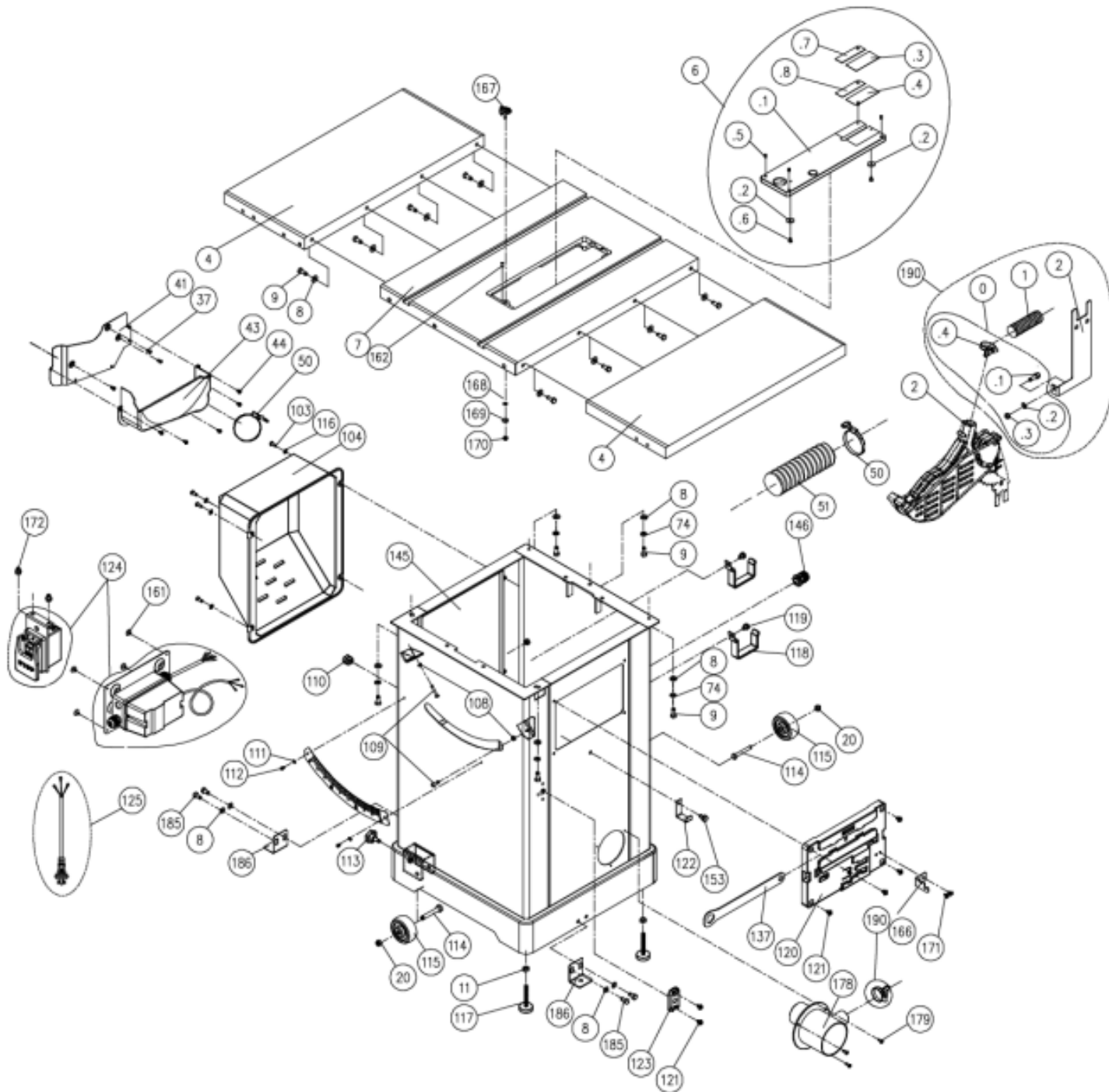

Internal

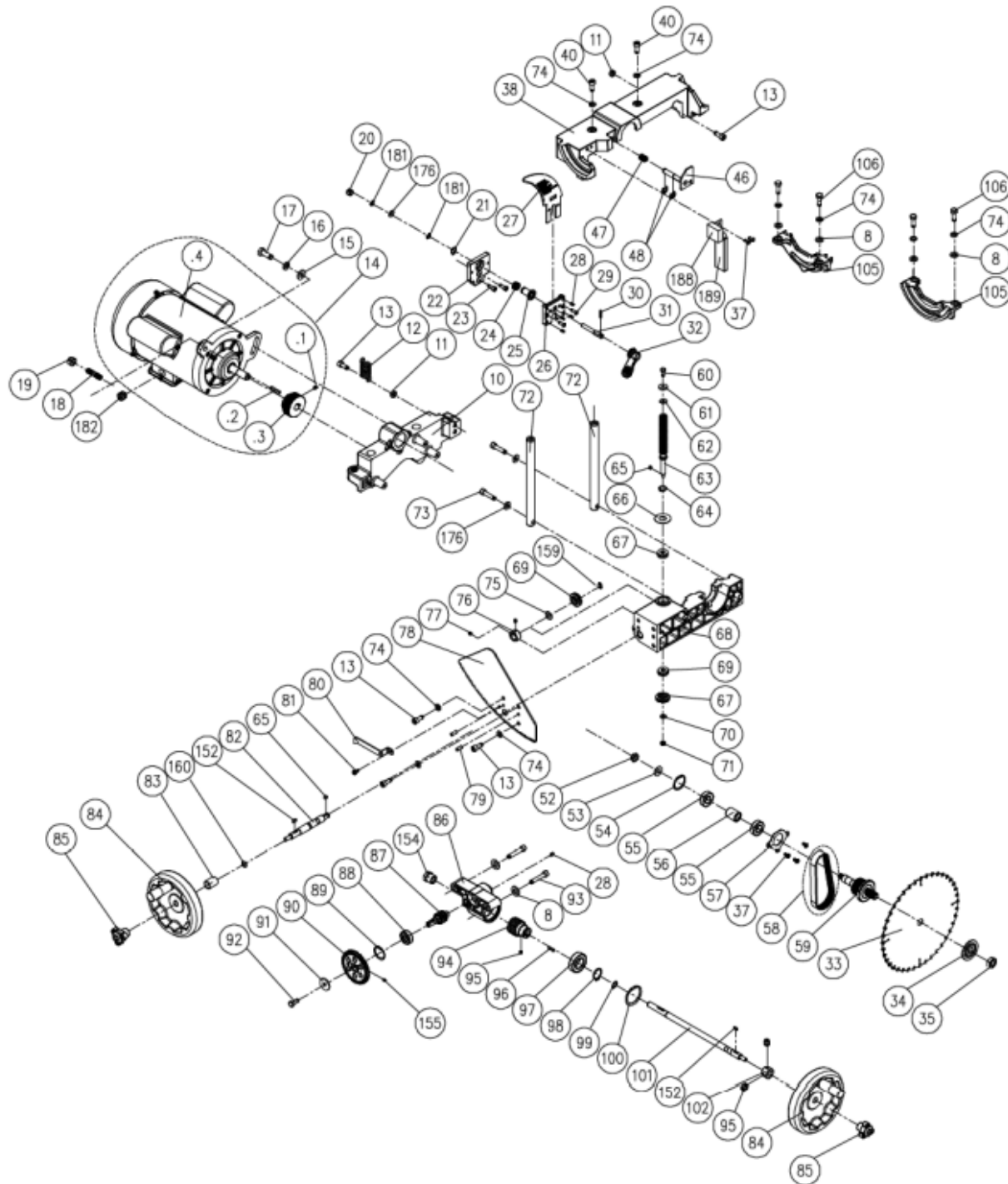

Blade Guard & Mitre Gauge

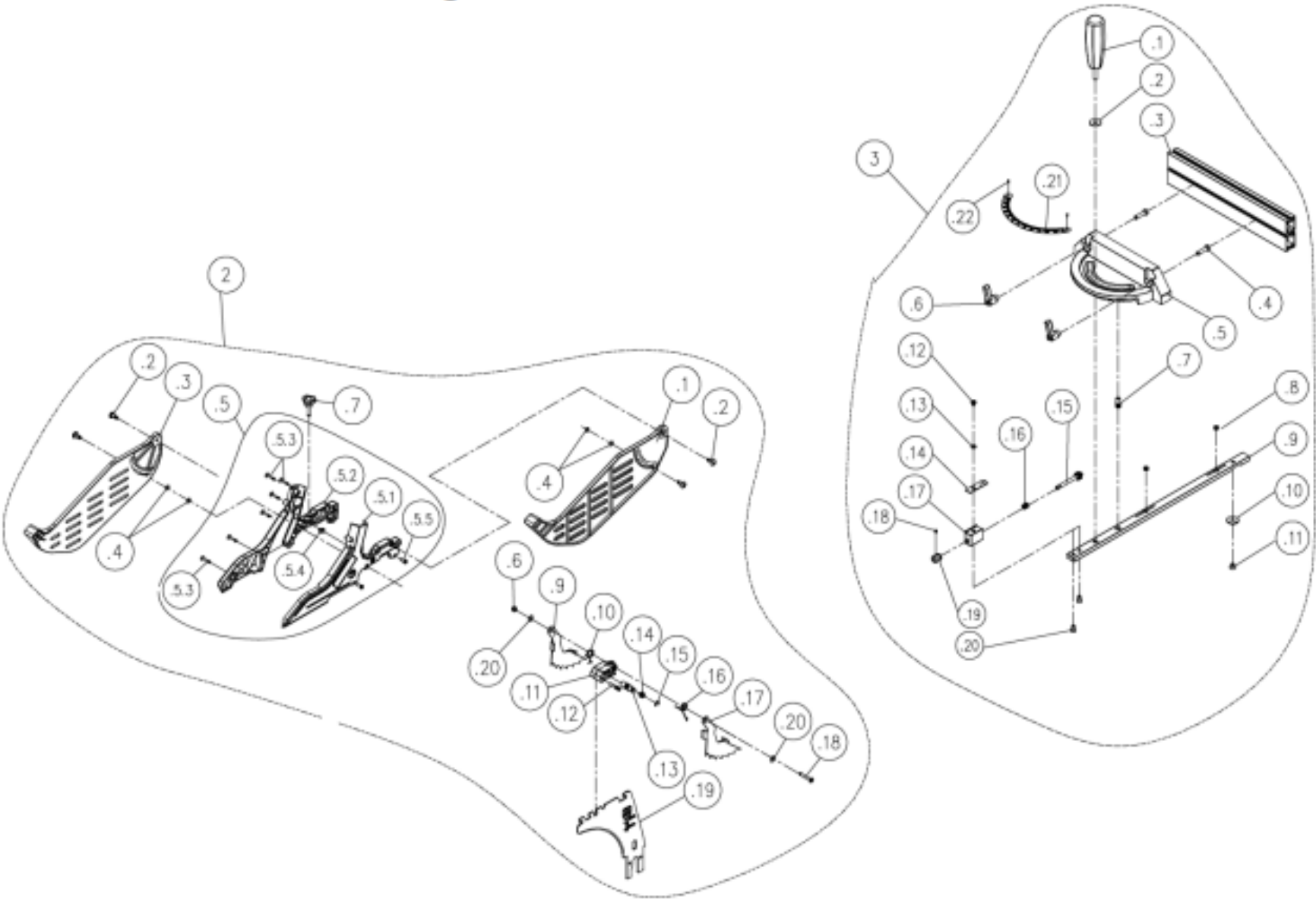

36" Rails & Fence

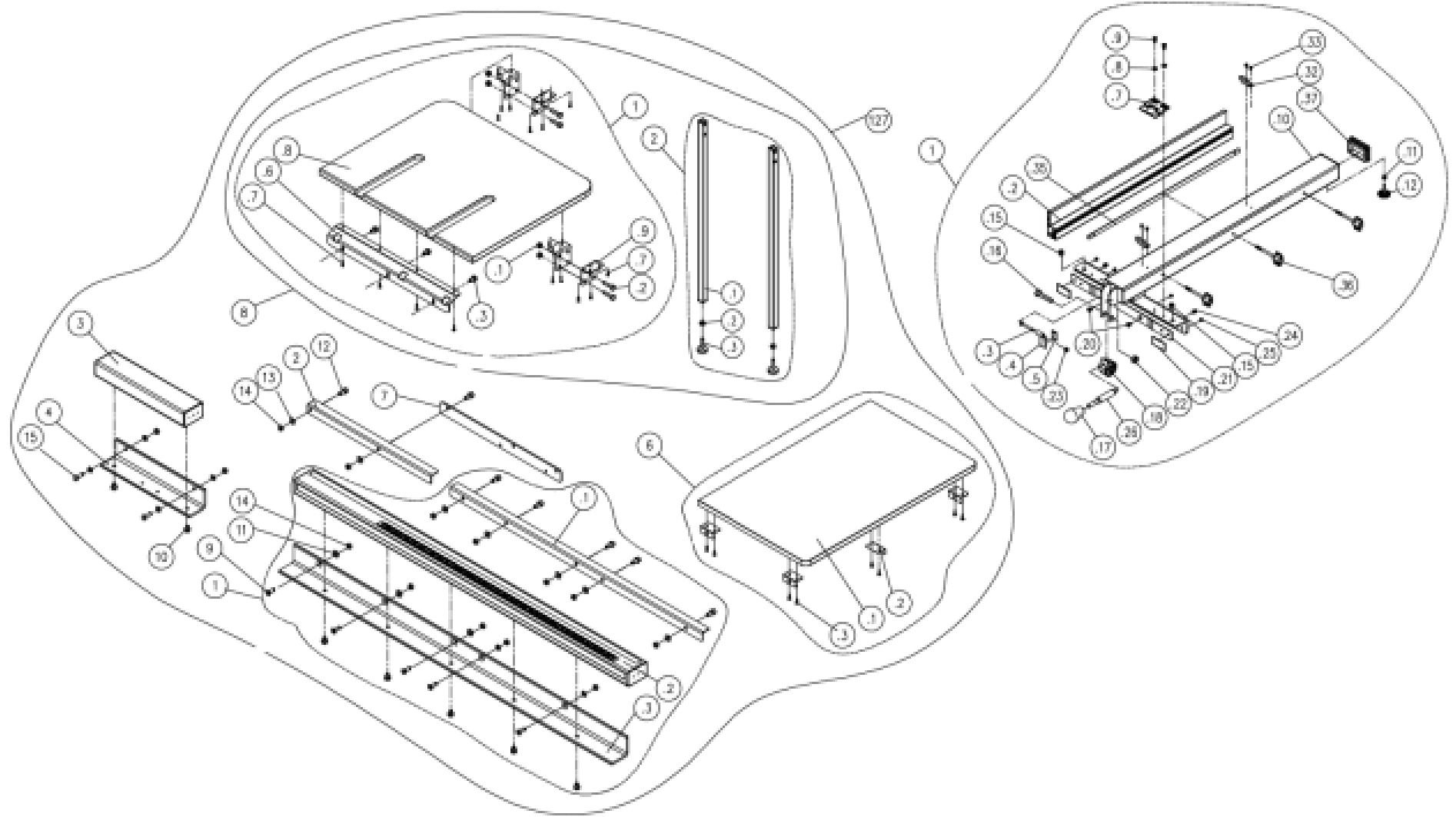

52" Rails & Fence

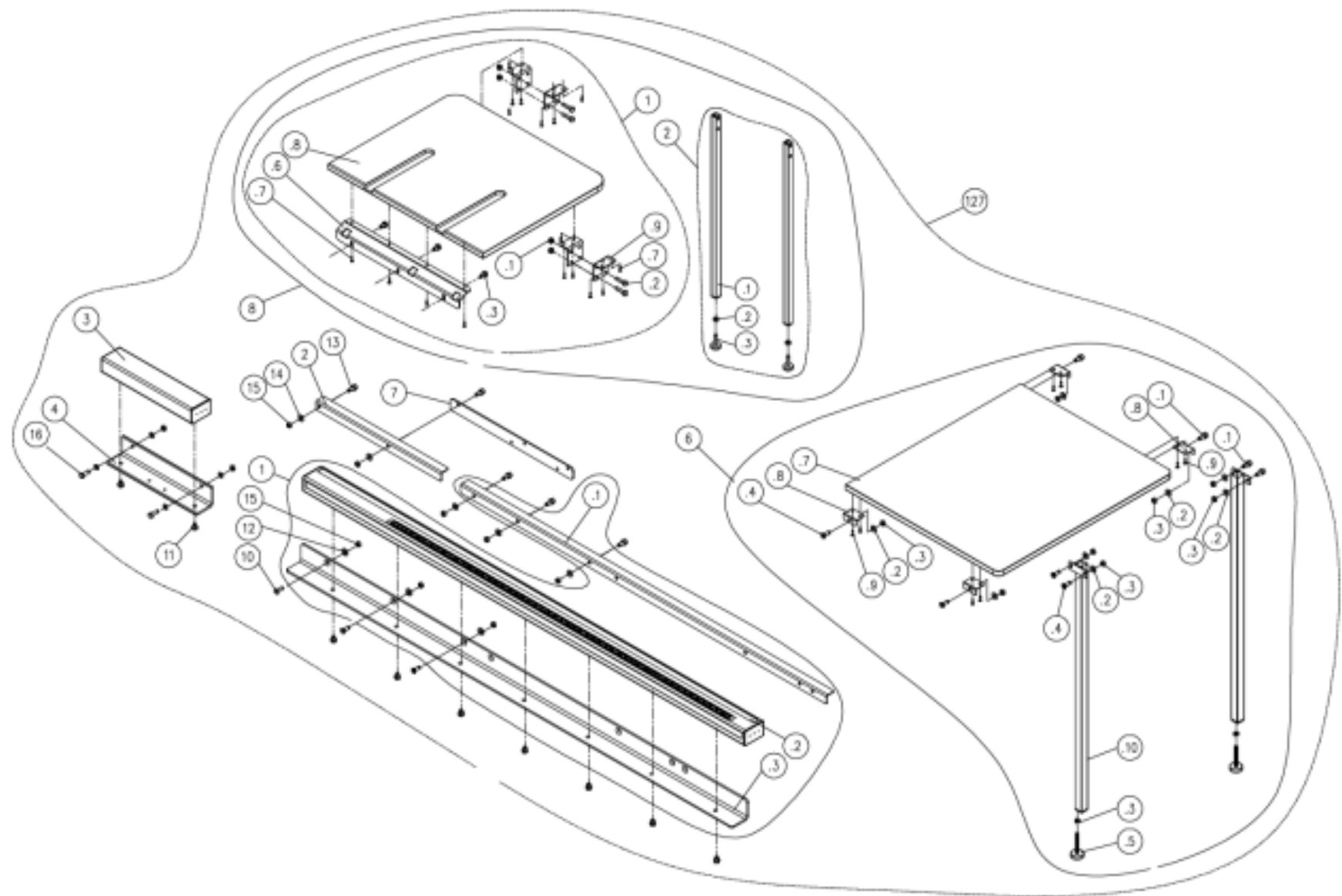

Replacement Parts Table

Key	Description	Specification	Q'ty	Part Number	Service Reference
1	Fence Assembly		1	PTSF3362203-0130-1	924913-001
1.2	Adaptor		1	PTSF3362203-0130-1.2	310511-909
1.3	Hex. Screw	M6*1.0P*45	1	PTSF3362203-0130-1.3	000002-308
1.4	Bracket		1	PTSF3362203-0130-1.4	171993-904
1.5	Frictional Plate		1	PTSF3362203-0130-1.5	250602-621
1.7	Pointer		1	PTSF3362203-0130-1.7	250470-620
1.8	Flat Washer	6.3*13*2.0t	2	PTSF3362203-0130-1.8	006002-023
1.9	Pan Head Screw	M6*1.0P*12	2	PTSF3362203-0130-1.9	000304-203
1.10	Fence Body		1	PTSF3362203-0130-1.10	174903-308
1.11	Hex. Nut	M6*1.0P(10B*5H)	1	PTSF3362203-0130-1.11	008005-100
1.12	Frictional Wheel		1	PTSF3362203-0130-1.12	250587-615
1.15	Plastic Set Screw	M12*1.75P	2	PTSF3362203-0130-1.15	250472-621
1.16	Hex. Screw	M10*1.5P*50	1	PTSF3362203-0130-1.16	000004-306
1.17	Ball		1	PTSF3362203-0130-1.17	230282-615
1.18	Compress Cam Assembly		1	PTSF3362203-0130-1.18	922141-001
1.19	Frictional Plate		2	PTSF3362203-0130-1.19	250471-621
1.20	Flat Head Screw	M6*1.0P*8	2	PTSF3362203-0130-1.20	002103-103
1.21	Bracket for Frictional Plate		1	PTSF3362203-0130-1.21	171372-904
1.22	Lock Nut	M10*1.5P(17B*12H)	1	PTSF3362203-0130-1.22	008308-100
1.23	Lock Nut	M6*1.0P(10B*6H)	1	PTSF3362203-0130-1.23	008304-100
1.24	SET Lock Screw	M8*1.25P*8	2	PTSF3362203-0130-1.24	001903-105
1.25	Spacer		4	PTSF3362203-0130-1.25	250672-615
1.26	Handle Shaft		1	PTSF3362203-0130-1.26	380883-904
1.32	Spring Plate		2	PTSF3362203-0130-1.32	270007-901
1.33	Pan Head Screw	M4*0.7P*6	4	PTSF3362203-0130-1.33	000302-101
1.35	Fix Plate		1	PTSF3362203-0130-1.35	174713-000
1.36	Wing Screw		3	PTSF3362203-0130-1.36	251433-615
1.37	End Cap		1	PTSF3362203-0130-1.37	250624-615
2	Blade Guard Assembly		1	PTSF3362203-0130-2	924883-001
2.1	Right Cover		1	PTSF3362203-0130-2.1	251246-000
2.2	Shoulder Shaft		4	PTSF3362203-0130-2.2	290073-905
2.3	Left Cover		1	PTSF3362203-0130-2.3	251247-000
2.4	O-Ring	P006	4	PTSF3362203-0130-2.4	043317-000
2.5	Blade Guard support Assembly		1	PTSF3362203-0130-2.5	924884-001
2.5.1	Support (L)		1	PTSF3362203-0130-2.5.1	924885-001
2.5.2	Support (R)		1	PTSF3362203-0130-2.5.2	924886-001
2.5.3	Tapping Screw	M4*1.41P*20	6	PTSF3362203-0130-2.5.3	001201-002
2.5.4	Hex. Nut	M6*1.0P(10B*5H)	1	PTSF3362203-0130-2.5.4	008005-200

Key	Description	Specification	Q'ty	Part Number	Service Reference
2.5.5	Pin		2	PTSF3362203-0130-2.5.5	360960-901
2.6	Lock Nut	M5*0.8P(8B*6H)	1	PTSF3362203-0130-2.6	008302-100
2.7	Bolt		1	PTSF3362203-0130-2.7	230336-615
2.9	Anti-Kick Finger -Left		1	PTSF3362203-0130-2.9	171378-904
2.10	Spring		1	PTSF3362203-0130-2.10	280162-901
2.11	Block		1	PTSF3362203-0130-2.11	251311-615
2.12	Pin		1	PTSF3362203-0130-2.12	360864-000
2.13	Spreader Shaft		1	PTSF3362203-0130-2.13	360865-901
2.14	Spring		1	PTSF3362203-0130-2.14	280160-901
2.15	Retaining Ring	ETW-7	1	PTSF3362203-0130-2.15	010204-000
2.16	Spring		1	PTSF3362203-0130-2.16	280163-901
2.17	Anti-Kick Finger -Right		1	PTSF3362203-0130-2.17	171379-904
2.18	Pan Head Phillip Screw	M5*0.8P*30	1	PTSF3362203-0130-2.18	000303-110
2.19	Spreader		1	PTSF3362203-0130-2.19	174397-904
2.20	Flat Washer	5.3*12*1.0t	2	PTSF3362203-0130-2.20	006001-012
3	Miter Gauge Assy		1	PTSF3362203-0130-3	924562-001
3.1	Handle		1	PTSF3362203-0130-3.1	230191-000
3.2	Flat Washer	8.5*23*2t	1	PTSF3362203-0130-3.2	006002-056
3.3	Apron		1	PTSF3362203-0130-3.3	310500-911
3.4	Hex. Screw	1/4"20NC*1"	2	PTSF3362203-0130-3.4	003001-102
3.5	Miter Gauge Body		1	PTSF3362203-0130-3.5	090342-008
3.6	Lock Handle		2	PTSF3362203-0130-3.6	230408-000
3.7	Pin		1	PTSF3362203-0130-3.7	360355-901
3.8	SET Screw	M8*1.25P*6	2	PTSF3362203-0130-3.8	000204-114
3.9	Slot Bar		1	PTSF3362203-0130-3.9	381390-904
3.10	Washer		1	PTSF3362203-0130-3.10	130380-903
3.11	Flat Head Phillip Screw	M6*1.0P*8	1	PTSF3362203-0130-3.11	000403-209
3.12	Pan Head Phillip Screw	M5*0.8P*8	1	PTSF3362203-0130-3.12	000303-202
3.13	Flat Washer	5.2*10*1.0t	1	PTSF3362203-0130-3.13	006002-009
3.14	Pointer		1	PTSF3362203-0130-3.14	251305-620
3.15	Adjusting Wheel Assembly		1	PTSF3362203-0130-3.15	924563-000
3.16	Spring		1	PTSF3362203-0130-3.16	280272-000
3.17	Spacer		1	PTSF3362203-0130-3.17	130378-903
3.18	SET Screw	M4*0.7P*4	1	PTSF3362203-0130-3.18	000201-105
3.19	Handle		1	PTSF3362203-0130-3.19	381388-904
3.20	Cap Screw	M5*0.8P*8	2	PTSF3362203-0130-3.20	000102-102
3.21	Scale		1	PTSF3362203-0130-3.21	574852-000
3.22	Rivet	2*5	2	PTSF3362203-0130-3.22	002301-201
4	Extension Table		2	PTSF3362203-0130-4	051386-000
6	Table Insert Assembly		1	PTSF3362203-0130-6	924397-001
6.1	Table Insert		1	PTSF3362203-0130-6.1	251262-663
6.2	Flat Washer	5.3*16*1.0t	2	PTSF3362203-0130-6.2	006011-187
6.3	Wear Plate -Right		1	PTSF3362203-0130-6.3	270077-902

Key	Description	Specification	Q'ty	Part Number	Service Reference
6.4	Double-Sided Adhesive	3M VHB F-9473 PC t=0.25mm	1	PTSF3362203-0130-6.4	420022-000
6.5	Set screw	M5*0.8P*12	4	PTSF3362203-0130-6.5	001901-104
6.6	Round Head Phillip Screw	M5*0.8P*8	2	PTSF3362203-0130-6.6	002002-101
6.7	Wear Plate -Left		1	PTSF3362203-0130-6.7	270078-902
6.8	Double-Sided Adhesive	3M VHB F-9473 PC t=0.25mm	1	PTSF3362203-0130-6.8	420023-000
7	Table		1	PTSF3362203-0130-7	051368-000
8	Flat Washer	8.5*16*2.0t	23	PTSF3362203-0130-8	006001-049
9	Hex. Screw	M8*1.25P*20	13	PTSF3362203-0130-9	000003-104
10	Up-down Bracket		1	PTSF3362203-0130-10	051370-000
11	Hex Nut	M8*1.25P(13B*6.5H)	4	PTSF3362203-0130-11	008006-100
12	Spring		1	PTSF3362203-0130-12	280258-905
13	Cap Screw	M8*1.25P*20	5	PTSF3362203-0130-13	000104-106
14	Motor Assy	3HP*230V*60HZ*1PH*2P	1	PTSF3362203-0130-14	901081-001
14.1	SET Lock Screw	M6*1.0P*8	1	PTSF3362203-0130-14.1	001902-110
14.2	Key	5*5*30	1	PTSF3362203-0130-14.2	012202-002
14.3	Motor Pulley	60HZ	1	PTSF3362203-0130-14.3	381282-902
14.4	Motor	3HP*220V~240V*60HZ*1PH*2P*13.9A	1	PTSF3362203-0130-14.4	603145-000
15	Flat Washer	10*20*3.0t	1	PTSF3362203-0130-15	006001-069
16	Spring Washer	10.2*18.5	1	PTSF3362203-0130-16	006307-100
17	Hex. Screw	M10*1.5P*30	1	PTSF3362203-0130-17	000004-103
18	Motor Fixing Shaft		1	PTSF3362203-0130-18	360863-901
19	Lock Nut	M10*1.5P(17B*12H)	1	PTSF3362203-0130-19	008308-100
20	Lock Nut	M8*1.25P(13B*9H)	3	PTSF3362203-0130-20	008306-100
21	Retaining Ring	STW-14	1	PTSF3362203-0130-21	010005-000
22	Bracket for Riving Knife		1	PTSF3362203-0130-22	130359-903
23	Cap Screw	M8*1.25P*16	2	PTSF3362203-0130-23	000104-104
24	Spring		1	PTSF3362203-0130-24	280259-901
25	Bushing		1	PTSF3362203-0130-25	130363-903
26	Block		1	PTSF3362203-0130-26	130360-903
27	Riving Knife		1	PTSF3362203-0130-27	174396-904
28	SET Lock Screw	M6*1.0P*8	5	PTSF3362203-0130-28	001902-110
29	Round Head Screw	M5*0.8P*16	2	PTSF3362203-0130-29	000804-106
30	Pin		1	PTSF3362203-0130-30	361251-905
31	Fixing Knob		1	PTSF3362203-0130-31	361250-901
32	Lock Handle		1	PTSF3362203-0130-32	110071-000
33	Sawblade	10"*40T	1	PTSF3362203-0130-33	390017-000
34	Sawblade clamp		1	PTSF3362203-0130-34	174399-901
35	Nut	TW5/8"-12	1	PTSF3362203-0130-35	380205-901
37	Round Head Socket Lock Screw	M5*0.8P*12	8	PTSF3362203-0130-37	002503-101
38	Upper Trunnion		1	PTSF3362203-0130-38	051369-000
40	Locking CAP screw	M8*1.25P*25	2	PTSF3362203-0130-40	002601-107
41	Fixing Plate		1	PTSF3362203-0130-41	174773-000

Key	Description	Specification	Q'ty	Part Number	Service Reference
43	Dust Hood		1	PTSF3362203-0130-43	251398-615
44	Round Head Phillip Screw	M5*0.8P*8	5	PTSF3362203-0130-44	002002-101
46	Arbor Lock Handle		1	PTSF3362203-0130-46	174325-156
47	Spring		1	PTSF3362203-0130-47	280260-901
48	Retaining Ring		2	PTSF3362203-0130-48	010206-000
50	Clamp	60-80mm(I.D.)	2	PTSF3362203-0130-50	042608-000
51	Dust Hose	2.5"*800mm	1	PTSF3362203-0130-51	042620-008
52	Lock Nut	M10*1.5P(17B*8H)	1	PTSF3362203-0130-52	008316-200
53	Flat Washer	10.3*22*2.0t	1	PTSF3362203-0130-53	006001-075
54	Retaining Ring	RTW-35	1	PTSF3362203-0130-54	010103-000
55	Ball Bearing	6003	2	PTSF3362203-0130-55	030211-002
56	Spacer		1	PTSF3362203-0130-56	190270-901
57	Fixed Plate		1	PTSF3362203-0130-57	174305-901
58	Poly-V-Belt	135J7	1	PTSF3362203-0130-58	014354-000
59	Arbor		1	PTSF3362203-0130-59	381281-902
60	Hex. Screw	M6*1.0P*16	1	PTSF3362203-0130-60	000002-103
61	Flat Washer	6.2*20*3.0t	1	PTSF3362203-0130-61	006001-020
62	Flat Washer	6.4*16*1.6t	1	PTSF3362203-0130-62	006007-114
63	Lead Screw		1	PTSF3362203-0130-63	361245-901
64	Retaining Ring	STW-16	1	PTSF3362203-0130-64	010007-000
65	Key	4*4*8	2	PTSF3362203-0130-65	012002-003
66	Washer		1	PTSF3362203-0130-66	174324-000
67	Bearing	51100	2	PTSF3362203-0130-67	031011-001
68	Trunnion Base		1	PTSF3362203-0130-68	090324-000
69	Bevel Gear		2	PTSF3362203-0130-69	130257-000
70	Flat Washer	6.4*16*1.0t	1	PTSF3362203-0130-70	006001-025
71	Lock Nut	M6*1.0P(10B*5H)	2	PTSF3362203-0130-71	008317-300
72	Column		2	PTSF3362203-0130-72	361246-000
73	Locking CAP screw	M8*1.25P*35	2	PTSF3362203-0130-73	002601-108
74	Spring Washer	8.2*15.4	14	PTSF3362203-0130-74	006305-100
75	Flat Washer	10.5*19*1.5t	1	PTSF3362203-0130-75	006001-078
76	Bushing		1	PTSF3362203-0130-76	190273-901
77	SET Screw	M5*0.8P*5	2	PTSF3362203-0130-77	000202-101
78	Rotary Gear Plate		1	PTSF3362203-0130-78	174309-901
79	Spring Pin	6*16	2	PTSF3362203-0130-79	011004-101
80	Pointer		1	PTSF3362203-0130-80	174322-156
81	Round Head Lock Screw w/Washer	M5*0.8P*12/5*10.5*1.0t	1	PTSF3362203-0130-81	002402-101
82	Shaft		1	PTSF3362203-0130-82	361261-901
83	Bushing		1	PTSF3362203-0130-83	251276-615
84	Handwheel Assembly		2	PTSF3362203-0130-84	924505-000
85	Fixing Knob		2	PTSF3362203-0130-85	920703-000
86	Worm Gear Box		1	PTSF3362203-0130-86	090326-000
87	Worm Gear Shaft		1	PTSF3362203-0130-87	320395-901
88	Ball Bearing	6201	1	PTSF3362203-0130-88	030106-001

Key	Description	Specification	Q'ty	Part Number	Service Reference
89	Retaining Ring	RTW-32	1	PTSF3362203-0130-89	010102-000
90	Gear		1	PTSF3362203-0130-90	130361-000
91	Flat Washer	5.5*22*2.0t	1	PTSF3362203-0130-91	006001-127
92	Hex. Screw	M5*0.8P*12	1	PTSF3362203-0130-92	000001-109
93	Cap Screw	M8*1.25P*45	2	PTSF3362203-0130-93	000104-113
94	Worm Shaft		1	PTSF3362203-0130-94	320394-901
95	Set screw	M6*1.0P*6	3	PTSF3362203-0130-95	001902-109
96	Key	4*4*20	1	PTSF3362203-0130-96	012002-007
97	Ball Bearing	6005	1	PTSF3362203-0130-97	030104-001
98	Retaining Ring	STW-25	1	PTSF3362203-0130-98	010011-000
99	Retaining Ring	STW-13	1	PTSF3362203-0130-99	010004-000
100	Retaining Ring	RTW-47	1	PTSF3362203-0130-100	010107-000
101	Shaft		1	PTSF3362203-0130-101	361262-901
102	Bushing		1	PTSF3362203-0130-102	360734-901
103	Pan Head Screw	M6*1.0P*16	4	PTSF3362203-0130-103	000304-107
104	Motor Cover		1	PTSF3362203-0130-104	251239-615
105	Trunnion Support		2	PTSF3362203-0130-105	051135-000
106	Hex. Screw	M8*1.25P*25	4	PTSF3362203-0130-106	000003-105
108	Hex Nut	M6*1.0P(10B*5H)	2	PTSF3362203-0130-108	008005-100
109	Hex. Screw	M6*1.0P*25	2	PTSF3362203-0130-109	000002-105
110	Strain Relief	SB7R-3	1	PTSF3362203-0130-110	020003-000
111	Flat Washer	4.3*10*1.0t	2	PTSF3362203-0130-111	006001-001
112	Pan Head Screw	M4*0.7P*8	2	PTSF3362203-0130-112	000302-102
113	Knob	5/16"-18NC*3/4"	2	PTSF3362203-0130-113	004001-101
114	Hex. Screw	M8*1.25P*60	2	PTSF3362203-0130-114	000003-316
115	Wheel		2	PTSF3362203-0130-115	250399-615
116	Flat Washer	6.3*13*1.0t	4	PTSF3362203-0130-116	006001-022
117	Leveling foot		2	PTSF3362203-0130-117	230041-000
120	Storage Box		1	PTSF3362203-0130-120	251251-615
121	Round Head Screw w/Washer	M6*1.0P*10/6*13.2*1.0t	6	PTSF3362203-0130-121	001603-102
122	Fix Plate		1	PTSF3362203-0130-122	170965-904
123	Worm Shaft Bracket		1	PTSF3362203-0130-123	250407-615
124	Magnetic Switch Assy	3HP	1	PTSF3362203-0130-124	937880-001
124.1	Magnetic Switch Assy	KJD17B-230V	1	PTSF3362203-0130-124.1	937881-001
124.2	Magnetic Switch Assy	No Button	1	PTSF3362203-0130-124.2	937882-001
125	Power Cord	SJT14AWG*3C*2550mm	1	PTSF3362203-0130-125	453012-023
127-A	36" Rail. Right Table. Rear Table Assembly		1	PTSF3362203-0130-127-A	924914-001
127-A1	36" Rail Assembly	36"	1	PTSF3362203-0130-127-A1	924915-001
127-A1.1	Rear Rail	36"	1	PTSF3362203-0130-127-A1.1	924923-001
127-A1.2	Front Rail Assembly	36"	1	PTSF3362203-0130-127-A1.2	924916-001
127-A1.3	Front Rail Bracket	36"	1	PTSF3362203-0130-127-A1.3	924917-001
127-A2	Rear Rail (L)		1	PTSF3362203-0130-127-A2	924783-001
127-A3	Front Rail (L)		1	PTSF3362203-0130-127-A3	924768-001
127-A4	Front Rail Bracket (L)		1	PTSF3362203-0130-127-A4	924772-001
127-A6	Right Table Assembly			PTSF3362203-0130-127-A6	924773-000

Key	Description	Specification	Q'ty	Part Number	Service Reference
127-A6.1	Right Table		1	PTSF3362203-0130-127-A6.1	440098-000
127-A6.2	Brace		4	PTSF3362203-0130-127-A6.2	173139-902
127-A6.3	Tapping Screw		8	PTSF3362203-0130-127-A6.3	230086-901
127-A7	Connect Plate			PTSF3362203-0130-127-A7	924969-001
127-A8	Rear Table . Leg Assembly		1	PTSF3362203-0130-127-A8	924796-001
127-A8.1	Rear Table Assembly		1	PTSF3362203-0130-127-A8.1	924797-001
127-A8.1.1	Lock Nut	M10*1.5P(17B*12H)	4	PTSF3362203-0130-127-A8.1.1	008308-100
127-A8.1.2	Hex. Screw	M10*1.5P*45	4	PTSF3362203-0130-127-A8.1.2	000004-112
127-A8.1.3	Hex. Screw w/Flat Washer	M8*1.25P*16/(13B*6.5H)	3	PTSF3362203-0130-127-A8.1.3	049201-101
127-A8.1.5	Support Plate		1	PTSF3362203-0130-127-A8.1.5	174780-904
127-A8.1.6	Round Hear Tapping Screw	M4*1.59P*16	16	PTSF3362203-0130-127-A8.1.6	001102-505
127-A8.1.7	Rear Table		1	PTSF3362203-0130-127-A8.1.7	440099-000
127-A8.2	Leg Assembly		1	PTSF3362203-0130-127-A8.2	924798-001
127-A8.2.1	Leg		2	PTSF3362203-0130-127-A8.2.1	190208-365
127-A8.2.2	Hex. Nut	M8*1.25P(13B*6.5H)	2	PTSF3362203-0130-127-A8.2.2	008006-100
127-A8.2.3	Leveling foot	S20C+NBR	2	PTSF3362203-0130-127-A8.2.3	230041-000
127-A9	Flat Head Hex. Screw	M8*1.25P*25	5	PTSF3362203-0130-127-A9	000704-102
127-A10	Hex. Screw w/Flat Washer	M8*1.25P*12/(13B*5.5H)	7	PTSF3362203-0130-127-A10	049201-102
127-A11	Spring Washer	8.2*15.4	3	PTSF3362203-0130-127-A11	006305-100
127-A12	CAP Screw w/ Spring Washer	M8*1.25P*25/8.2*13.7	7	PTSF3362203-0130-127-A12	001803-103
127-A13	Flat Washer	8.5*16*2.0t	16	PTSF3362203-0130-127-A13	006001-049
127-A14	Hex. Nut	M8*1.25P(13B*6.5H)	14	PTSF3362203-0130-127-A14	008006-100
127-A15	Hex. Screw	M8*1.25P*25	2	PTSF3362203-0130-127-A15	000003-105
127-B	52" Rail. Right Table. Rear Table Assembly	52"	1	PTSF3362203-0130-127-B	924970-001
127-B1	52" Rail Assembly	52"	1	PTSF3362203-0130-127-B1	924971-000
127-B1.1	Rear Rail	52"	1	PTSF3362203-0130-127-B1.1	924924-001
127-B1.2	Front Rail Assembly	52"	1	PTSF3362203-0130-127-B1.2	924920-002
127-B1.3	Front Rail Bracket	52"	1	PTSF3362203-0130-127-B1.3	924921-000
127-B2	Rear Rail (L)		1	PTSF3362203-0130-127-B2	924783-001
127-B3	Front Rail (L)		1	PTSF3362203-0130-127-B3	924768-001
127-B4	Front Rail Bracket (L)		1	PTSF3362203-0130-127-B4	924772-001
127-B6	Right Table		1	PTSF3362203-0130-127-B6	924809-001
127-B6.1	CAP Scewe w/Spring Washer	M8*1.25P*20/8.2*15.4	4	PTSF3362203-0130-127-B6.1	001803-102
127-B6.2	Flat Washer	8.5*16*2.0t	8	PTSF3362203-0130-127-B6.2	006001-049
127-B6.3	Hex. Nut	M8*1.25P(13B*6.5H)	10	PTSF3362203-0130-127-B6.3	008006-100
127-B6.4	Flat Head Hex. Screw	M8*1.25P*25	4	PTSF3362203-0130-127-B6.4	000704-102

Key	Description	Specification	Q'ty	Part Number	Service Reference
127-B6.5	Leveling foot		2	PTSF3362203-0130-127-B6.5	230041-000
127-B6.7	Right Table		1	PTSF3362203-0130-127-B6.7	440077-000
127-B6.8	Brace		4	PTSF3362203-0130-127-B6.8	173139-902
127-B6.9	Tapping Screw		8	PTSF3362203-0130-127-B6.9	230086-901
127-B6.10	Leg		2	PTSF3362203-0130-127-B6.10	190205-308
127-B7	Connect Plate		1	PTSF3362203-0130-127-B7	924969-000
127-B8	Rear Table Assembly		1	PTSF3362203-0130-127-B8	924796-000
127-B8.1	Rear Table Assembly		1	PTSF3362203-0130-127-B8.1	924797-000
127-B8.1.1	Lock Nut	M10*1.5P(17B*12H)	4	PTSF3362203-0130-127-B8.1.1	008308-100
127-B8.1.2	Hex. Screw	M10*1.5P*45	4	PTSF3362203-0130-127-B8.1.2	000004-112
127-B8.1.3	Hex. Screw w/ Flat Washer	M8*1.25P*16/(13B*6.5H)	3	PTSF3362203-0130-127-B8.1.3	049201-101
127-B8.1.5	Support Plate		1	PTSF3362203-0130-127-B8.1.5	174780-904
127-B8.1.6	Round Head Tapping Screw	M4*1.59P*16	16	PTSF3362203-0130-127-B8.1.6	001102-505
127-B8.1.7	Rear Table		1	PTSF3362203-0130-127-B8.1.7	440099-000
127-B8.1.8	Fixing Plate		4	PTSF3362203-0130-127-B8.1.8	171301-904
127-B8.2	Leg Assembly		1	PTSF3362203-0130-127-B8.2	924798-000
127-B8.2.1	Leg		2	PTSF3362203-0130-127-B8.2.1	190208-365
127-B8.2.2	Hex. Nut	M8*1.25P(13B*6.5H)	2	PTSF3362203-0130-127-B8.2.2	008006-100
127-B8.2.3	Leveling foot	S20C+NBR	2	PTSF3362203-0130-127-B8.2.3	230041-000
127-B10	Flat Head Hex. Screw	M8*1.25P*25	3	PTSF3362203-0130-127-B10	000704-102
127-B11	Hex. Screw w/Flat Washer	M8*1.25P*12/(13B*5.5H)	9	PTSF3362203-0130-127-B11	049201-102
127-B12	Spring Washer	8.2*15.4	3	PTSF3362203-0130-127-B12	006305-100
127-B13	CAP Screw w/ Spring Washer	M8*1.25P*25/8.2*13.7	5	PTSF3362203-0130-127-B13	001803-103
127-B14	Flat Washer	8.5*16*2.0t	9	PTSF3362203-0130-127-B14	006001-049
127-B15	Hex. Nut	M8*1.25P(13B*6.5H)	10	PTSF3362203-0130-127-B15	008006-100
127-B16	Hex. Nut	M8*1.25P*25	2	PTSF3362203-0130-127-B16	000003-105
118	Slide Shelf		2	PTSF3362203-0130-118	170541-904
119	Hex. Screw w/Flat Washer	M8*1.25P*16/(13B*6.5H)	2	PTSF3362203-0130-119	049201-101
130	Push Sticks		1	PTSF3362203-0130-130	251362-615
133	Hex. Wrench	2.5mm	1	PTSF3362203-0130-133	040002-000
188	Hex. Wrench	5mm	1	PTSF3362203-0130-188	040013-000
134	Hex. Wrench	6mm	1	PTSF3362203-0130-134	040006-000
135	Open Wrench	10*13	1	PTSF3362203-0130-135	174569-904
137	Arbor Wrench		1	PTSF3362203-0130-137	174315-904
140	Plastic Paper	1220*790*0.04t	1	PTSF3362203-0130-140	041501-004
145	Stand		1	PTSF3362203-0130-145	174469-000

Key	Description	Specification	Q'ty	Part Number	Service Reference
146	Strain Relief	PGA13.5-11B	1	PTSF3362203-0130-146	021311-000
152	Key	4*4*12	2	PTSF3362203-0130-152	012002-005
153	Hex Screw w/Washer	M8*1.25P*16/(13B*6.5H)	1	PTSF3362203-0130-153	049201-101
154	Adjusting Bushing		1	PTSF3362203-0130-154	130368-903
155	Set screw	M5*0.8P*5	1	PTSF3362203-0130-155	001901-101
159	Retaining Ring	STW-10	1	PTSF3362203-0130-159	010001-000
160	O-Ring	P11	1	PTSF3362203-0130-160	043322-000
161	Round Head Lock Screw w/Washer	M5*0.8P*10-5*16*1.5t	4	PTSF3362203-0130-161	002402-102
162	Spring Pin	3*10	1	PTSF3362203-0130-162	011001-103
166	Hook		1	PTSF3362203-0130-166	174398-904
167	Knob		1	PTSF3362203-0130-167	251243-615
168	Wave Washer	WW-6	1	PTSF3362203-0130-168	006701-100
169	Flat Washer	5.3*16*1.5t	1	PTSF3362203-0130-169	006001-137
170	Lock Nut	M5*0.8P(8B*6H)	1	PTSF3362203-0130-170	008302-100
171	Round Head Tapping Screw	M5*2.12P*12	2	PTSF3362203-0130-171	001104-703
172	Hex Screw w/Washer	M8*1.25P*12/(13B*5.5H)	2	PTSF3362203-0130-172	049201-102
175	Plastic Paper	750*1400*0.1t	1	PTSF3362203-0130-175	041502-010
176	Flat Washer	8.5*16*1.0t	3	PTSF3362203-0130-176	006001-045
178	Adaptor		1	PTSF3362203-0130-178	251418-615
179	Pan Head Screw	M5*0.8P*12	3	PTSF3362203-0130-179	000303-104
181	Wave Washer	WW-8	2	PTSF3362203-0130-181	006702-100
182	Strain Relief	SB7R-1	1	PTSF3362203-0130-182	020002-000
185	Hex. Screw	M8*1.25P*16	4	PTSF3362203-0130-185	000003-102
186	Fix Plate		2	PTSF3362203-0130-186	174711-000
188	Sponge		1	PTSF3362203-0130-188	200108-000
189	Plate		1	PTSF3362203-0130-189	174772-000
190	Over Head Guards Assembly	36"		PTSF3362203-0130-190	924854-001
190.1	Dust Hose	1.5"*2700mm	1	PTSF3362203-0130-190.1	042620-015
190.2	Brace		1	PTSF3362203-0130-190.2	174887-904
190.3	Hardware Bage for Over Head Guard	36"	1	PTSF3362203-0130-190.3	850913-001
190.3.1	CAP Screw w/ Spring Washer	M8*1.25P*25/8.2*13.7	1	PTSF3362203-0130-190.3.1	001803-103
190.3.2	Flat Washer	8.5*16*2.0t	1	PTSF3362203-0130-190.3.2	006001-049
190.3.3	Hex Nut	M8*1.25P(13B*6.5H)	1	PTSF3362203-0130-190.3.3	008006-100
190.3.4	Clamp	1.5"	2	PTSF3362203-0130-190.3.4	042622-001

Delivery Protocol-

- Most large machinery will be delivering on a tractor trailer 48'-53' long. Please notify Sales Representative with any Delivery Restrictions.
- Customer is required to have a forklift (6000lb. or larger is recommended) with 72" forks or fork extensions and operator.
- Note any visible damage, torn packaging, scuffs or any abnormal marks on the delivery receipt or Bill of Lading (BOL).

SHIP FROM		SHIP TO		FREIGHT CHARGES BILL TO	
Name: Address: City/State/Zip:		Name: Address: City/State/Zip:		Name: Address: City/State/Zip:	
Bill of Lading Number : 145787446		Carrier Name: Estes Express		SCAC: EXLA Pro number:	
Freight Charge Terms: (freight charges are prepaid by Worldwide Express unless indicated otherwise)		Master Bill of Lading: with attached underlying Bill Of Lading		WWE Number: W709699351	
SPECIAL INSTRUCTIONS: For assistance, please call 833-8WE-SHIP Handling Instructions: RMACR11096 Pickup Instructions: Delivery Instructions: RMACR11096 Pickup Service(s): Liftgate Pickup, Residential Pickup					
REFERENCE NUMBER INFORMATION					
REFERENCE	# PKGS	REFERENCE	# PKGS	Total # of Pkgs	
CARRIER INFORMATION					
HANDLING UNITS	PIECES	WEIGHT	H.M. X	COMMODITY DESCRIPTION	LTL ONLY
QTY	TYPE	QTY	TYPE		NMFC# CLASS
1	PLT	385		Machine, 48(L) x 48(W) x (H) DO NOT STACK	77.5
1		385		Grand Total	
Where the rate is dependent on value, shippers are required to state specifically in writing the agreed or declared value of property as follows: The agreed or declared value of the property is specifically stated by the shipper to be not exceeding \$_____ per			COD Amount: \$ Fee Terms: 3 rd Party WWE Remit Address:		Acceptable Forms of Payment: Bank Certified Check <input type="checkbox"/> Customer Check <input type="checkbox"/> Personal Check <input type="checkbox"/> Money Order <input type="checkbox"/>
Note: Liability limitation for loss or damage in this shipment may be applicable. See 49 U.S.C. B14706(c)(1)(A) and (B).			CARRIER SIGNATURE / PICKUP DATE Carrier acknowledges receipt of packages and required placards. Carrier certifies emergency response information was made available and for carrier has DOT emergency response guidebook or equivalent documentation in vehicle. Property described above is received in good order, except as noted.		
SHIPPER'S SIGNATURE / DATE This is to certify that the above-named materials are properly classified, described, packaged, marked and labeled, and are in proper condition for transportation according to the applicable regulations of the Department of Transportation.		Trailer Loaded: <input type="checkbox"/> By Shipper <input type="checkbox"/> By Driver	Freight Counted: <input type="checkbox"/> By Shipper <input type="checkbox"/> By Driver/pallet said to contain <input type="checkbox"/> By Driver/Pieces		
_____ (Signature)		_____ (Date)		_____ (Signature) _____ (Date)	

Bill of Lading Number : 145787446

SPECIAL INSTRUCTIONS: For assistance, please call 833-8WE-SHIP
Handling Instructions: RMACR11096
Pickup Instructions:
Delivery Instructions: RMACR11096
Pickup Service(s): Liftgate Pickup, Residential Pickup

Laguna Tools Warranty-

Dealer Machinery Warranty

- New woodworking machines sold by Laguna Tools carry a two-year warranty effective from the date of dealer invoice to customer/end-user. Machines sold through dealers must be registered with Laguna Tools within 30 days of purchase to be covered by this warranty. Laguna Tools guarantees all new machine sold to be free of manufacturers' defective workmanship, parts, and materials. We will repair or replace, without charge, any parts determined by Laguna Tools, Inc. to be a manufacturer's defect. We require that the defective item/part be returned to Laguna Tools with the complaint. The end-user must request an RMA (return material authorization) number from Customer Service and include the (RMA) number with all returned parts/components requesting warranty coverage.* Any machines returned to Laguna Tools must be returned with packaging in the same way it was received. If a part or blade is being returned it must have adequate packaging to ensure no damage is received during shipping. In the event the item/part is determined to be damaged due to lack of maintenance, cleaning or misuse/abuse, the customer will be responsible for the cost to replace the item/part, plus all related shipping charges. This limited warranty does not apply to natural disasters, acts of terrorism, normal wear and tear, product failure due to lack of maintenance or cleaning, damage caused by accident, neglect, lack of or inadequate dust collection, misuse/abuse or damage caused where repair or alterations have been made or attempted by others.

****NOTE: Issuing an RMA number is for referencing materials and issues, it does NOT indicate warranty acceptance/conformity.**

Laguna Tools Warranty-

CNC Limited Warranty

New CNC machines sold by Laguna Tools carry a one-year warranty effective from the date of shipping. Laguna Tools guarantees all new machine sold to be free of manufacturers' defective workmanship, parts, and materials. We will repair or replace without charge, any parts determined by Laguna Tools, Inc. to be a manufacturer's defect. We require that the defective item/part be determined to be damaged due to lack of maintenance, cleaning or misuse/abuse, the customer will be responsible for the cost to replace the item/part, plus all related shipping charges. This limited warranty does not apply to natural disasters, acts of terrorism, normal wear and tear, product failure due to lack of maintenance or cleaning, damage caused by accident, neglect, lack of or inadequate dust collection, misuse/abuse or damage caused where repair or alterations have been made or attempted by others.

Laguna Tools, Inc. is not responsible for additional tools or modifications sold or performed (other than from/by Laguna Tools, Inc.) on any Laguna Tools, Inc. woodworking machine. Warranty maybe voided upon the addition of such described tools and/or modifications, determined on a case-by-case basis. Software purchased through Laguna Tools, Inc., is not covered under this warranty and all technical support must be managed through the software provider. Normal user alignment, adjustment, tuning, and machine settings are not covered by this warranty. It is the responsibility of the user to understand basic woodworking machinery settings and procedures and to properly maintain the equipment in accordance with the standards provided by the manufacturer.

Parts under warranty are shipped at Laguna Tools, Inc.'s cost either by common carrier, FEDEX ground service or a similar method. Technical support to install replacement parts is primarily provided by phone, fax, e-mail, or Laguna Tools Customer Support Website. The labor required to install replacement parts is the responsibility of the user. Laguna Tools is not responsible for damage or loss caused by a freight company or other circumstances not in our control. All claims for loss or damaged goods must be notified to Laguna Tools within twenty-four hours of delivery.

***Please contact our Customer Service Department for more information. Only NEW machines sold to the original owner are covered by this warranty. For warranty repair information, call 1-800-332-4094. Copyright 2013 Laguna Tools, Inc.

****Warning – no portion of these materials may be reproduced without written approval from Laguna Tools, Inc.**

Laguna Tools Warranty-

WARRANTY & REGISTRATION

THANK YOU!

Welcome to the Laguna Tools® group of discriminating woodworkers. We understand that you have a choice of where to purchase your machines and appreciate the confidence you have in the Laguna Tools® brand.

Through hands-on experience, Laguna Tools® is constantly working hard to make innovative, precision products. Products that inspire you to create works of art, are a joy to operate, and encourage your best work.

Laguna Tools®
Imagination, Innovation, and Invention at Work

WARRANTY & REGISTRATION

Every product sold is warranted to be free of manufacturers' defective workmanship, parts, and materials. For any questions about this product, the intended use or what it was designed for, customer service, or replacement parts, please contact our customer service department:

Laguna Tools® Customer Service
2072 Alton Parkway, Irvine, California 92606, USA
1-800-332-4049
customerservice@lagunatools.com
www.lagunatools.com/why/customer-service/
8AM. to 5PM PST, Monday through Friday

For warranty claims or to report damage upon receiving – please reach out to our warranty department:

Laguna Tools® Warranty Service
2072 Alton Parkway, Irvine, California 92606, USA
1-949-474-1200
customerservice@lagunatools.com
www.lagunatools.com/rpolicies/warranty
8AM to 5PM PST, Monday through Friday

REGISTRATION

To prevent voiding this warranty, all products sold must be registered within thirty (30) days of receiving the product. Registering the product will enable the original purchaser to receive notifications about important product changes, receive customer service, and be able to file a warranty claim against defective workmanship, parts, or materials.

WHO IS COVERED

The applicable warranty covers only the initial purchaser of the product from the date of receiving the product. To file such claims, the original purchaser must present the original receipt as proof of purchase.

WHAT IS COVERED

The warranty covers any defects in the workmanship of all parts and materials that make up the machine unless otherwise specified. Any part, determined by Laguna Tools®, to have a defect will be repaired or replaced (and shipped), without charge. The defective item/part must be returned to Laguna Tools® with the complaint and proof of purchase in the original packaging that it was received in. In the event the item/part is determined to be not covered by this warranty, the customer will be responsible for the cost to replace the item/part and all related shipping charges.



WARRANTY LIMITATIONS

This limited warranty does not apply to natural disasters, acts of terrorism, normal wear and tear, product failure due to lack of maintenance or cleaning, damage caused by accident, neglect, or lack-of inadequate dust collection. The warranty may be voided against proof of misuse/abuse, damage caused where repair or alterations have been made or attempted by others, using the product for purposes other than those described as intended use (unless with consent by Laguna Tools®), modification to the product, or use with an accessory that was not designed for the product. It is the responsibility of the user to understand basic woodworking machinery settings and procedures and to properly maintain the equipment in accordance with the standards provided in this manual.

LENGTH OF WARRANTY

All new machines and optional accessories sold through an authorized dealer carry a two-year warranty effective the date of receiving the product. Machines sold for either commercial or industrial use have a one-year warranty. Wearable parts like throat plates, bandsaw guides, etc., have a ninety-day warranty.

Table A-1 Warranty Lengths

2 Year – New Machines Sold Through an Authorized Dealer
2 Year – Accessories Sold as Machine Options (excluding blades)
1 Year – Machines Sold for Commercial or Industrial Use
1 Year – Blades and Accessories outside of Machine Options
90 Days – Wearable Parts

Aside from being free of defects upon receiving, consumable parts, like cutters and abrasives, are not covered by this warranty unless otherwise stated by Laguna Tools®. These parts are designed to be used at the expense of the operator and are available for replacement or inventory purchase. The determination of a consumable part will be made on a case-by-case basis by Laguna Tools®.

SHIPPING DAMAGE

Laguna Tools® is not responsible for damage or loss caused by a freight company or other circumstances not in the direct control of Laguna Tools®. All shipping-related claims for loss or damage goods must be made to Laguna Tools within twenty-four hours of delivery.

HOW TO RECEIVE SUPPORT

To file a warranty-claim please contact the warranty department at 1-949-474-1200. To receive customer service or technical support please contact the customer service department at 1-800-332-4094. Parts, under warranty, are shipped at the expense of Laguna Tools® either by common carrier, FedEx ground services or similar method. Technical support to install replacement parts is primarily provided by phone, fax, email, or the Laguna Tools Customer Support Website.

LAGUNA

Laguna Tools Warranty-

No Modifications Allowed or Sold.

Laguna Tools, Inc. is not responsible for additional tools or modifications sold or performed (other than from/by Laguna Tools, Inc.) on any Laguna Tools, Inc. woodworking machine. Warranty maybe voided upon the addition of such described tools and/or modifications, determined on a case-by-case basis. Normal user alignment, adjustment, tuning, and machine settings are not covered by this warranty. It is the responsibility of the user to understand basic woodworking machinery settings and procedures and to properly maintain the equipment in accordance with the standards provided by the manufacturer. Parts, under warranty, are shipped at Laguna Tools, Inc.'s cost either by common carrier, FEDEX ground service or a similar method. Technical support to install replacement parts is primarily provided by phone, fax, e-mail, or Laguna Tools Customer Support Website. The labor required to install replacement parts is the responsibility of the user. Laguna Tools is not responsible for damage or loss caused by a freight company or other circumstances not in our control. All claims for loss or damaged goods must be notified to Laguna Tools within twenty-four hours of delivery. Please contact our Customer Service Department for more information. Only new machines sold to the original owner are covered by this warranty.

For warranty repair information, call 1-800-332-4094.

Laguna Tools Packaging/RMA Procedures-

Dealer Machinery Warranty

****Any machines returned to Laguna Tools must be returned with packaging in the same way it was received. If a part or blade is being returned it must have adequate packaging to ensure no damage is received during shipping. In the event the item/part is determined to be damaged due to lack of maintenance, cleaning or misuse/abuse, the customer will be responsible for the cost to replace the item/part, plus all related shipping charges.**

We require that the defective item/part be returned to Laguna Tools with the complaint. The end-user must request an **RMA (Return Material Authorization) Number** from Customer Service and include the (RMA) number with all returned parts/components requesting warranty coverage.

Laguna Tools Packaging/Laguna Tools RMA Example-

12/1/2020 Return Authorization - NetSuite (Laguna Tools, Inc)

Return Authorization

CR10979 **PENDING RECEIPT**

Edit Back Receive Close **Actions**

CUSTOMER	CREATED FROM	Summary
DATE	SALES EFFECTIVE DATE	SUBTOTAL
CURRENCY	EST. EXTENDED COST	DISCOUNT
SUBSIDIARY	EST. GROSS PROFIT	GSTAMT
DEPARTMENT Sales	EST. GROSS PROFIT PERCENT	PST
LOCATION Laguna Texas Demo / Returns	PROMISE DATE	TOTAL
SALES REP	<input type="checkbox"/> DEPOSIT RECEIVED	
PARTNER	<input type="checkbox"/> ACCOUNTING APPROVAL	
LEAD SOURCE	COMMENTS	
PO #	RETURN REASON Manufacturers Warranty Defect	
PO-981	SHIP IMMEDIATE	
MEMO	SPLIT SHIP	
	<input type="checkbox"/> REVISED INVOICE	
	ORDER HOLD REASON	

SHIPPING COMMENTS

Items Promotions Address Messages History Workflow Custom Partners Sales Team Additional Information OzLINK Pagejet SPS

EXCHANGE RATE **RATE**

DISCOUNT

ITEM	RETURNED	REFUNDED	QUANTITY	UNITS	INVENTORY DETAIL	DESCRIPTION	PRICE LEVEL	UNIT PRICE	AMOUNT	TAX CODE	TAX RATE	PST	OPTIONS	GIFT CERTIFICATE	DROP CLOSED	SHIPMENT	CO EST TY1
																	Item De Co

Edit Back Receive Close **Actions**

RMA #

**RTN. AUTH. #
CR10979**

Laguna Tools Packaging/Laguna Tools BILL of LADING Example-

SHIP FROM		SHIP TO		FREIGHT CHARGES BILL TO					
Name: Address: City/State/Zip:		Name: Address: City/State/Zip:		Name: Address: City/State/Zip:					
Bill of Lading Number : 145787446		Carrier Name: Estes Express		SCAC: EXLA Pro number:					
FOB: <input type="checkbox"/>		Freight Charge Terms: (freight charges are prepaid by Worldwide Express unless indicated otherwise)		<input type="checkbox"/> Master Bill of Lading with attached underlying Bill Of Lading WVE Number: W709699351					
SPECIAL INSTRUCTIONS: For assistance, please call 833-8WE-SHIP Handling Instructions: RMACR11096 Pickup Instructions: Delivery Instructions: RMACR11096 Pickup Service(s): Liftgate Pickup, Residential Pickup									
REFERENCE NUMBER INFORMATION									
REFERENCE	# PKGS	REFERENCE	# PKGS	Total # of Pkgs					
CARRIER INFORMATION									
HANDLING UNITS		PIECES		WEIGHT	H.M. X	COMMODITY DESCRIPTION		LTL ONLY	
QTY	TYPE	QTY	TYPE			NMFC#	CLASS		
1	PLT			385		machine, 48(L) x 48(W) x (H) DO NOT STACK			77.5
1				385		Grand Total			
Where the rate is dependent on value, shippers are required to state specifically in writing the agreed or declared value of property as follows: The agreed or declared value of the property is specifically stated by the shipper to be not exceeding _____ per _____				COO Amount: \$ Fee Terms: 3 rd Party WVE Remit Address:		Acceptable Forms of Payment: <input type="checkbox"/> Bank Certified Check <input type="checkbox"/> Customer Check <input type="checkbox"/> Personal Check <input type="checkbox"/> Money Order			
Note: Liability limitation for loss or damage in this shipment may be applicable. See 49 U.S.C. B14706(c)(1)(A) and (B).				CARRIER SIGNATURE / PICKUP DATE		Carrier acknowledges receipt of packages and required placards. Carrier certifies emergency response information was made available and for carrier has DOT emergency response guidebook or equivalent documentation in vehicle. Property described above is received in good order, except as noted.			
SHIPPER'S SIGNATURE / DATE This is to certify that the above-named materials are properly classified, described, packaged marked and labeled, and are in proper condition for transportation according to the applicable regulations of the Department of Transportation.		Trailer Loaded: <input type="checkbox"/> By Shipper <input type="checkbox"/> By Driver		Freight Counted: <input type="checkbox"/> By Shipper <input type="checkbox"/> By Driver/pallet said to contain <input type="checkbox"/> By Driver/Pieces		(Signature) _____		(Date) _____	

Bill of Lading Number : 145787446

SPECIAL INSTRUCTIONS: For assistance, please call 833-8WE-SHIP
 Handling Instructions: RMACR11096
 Pickup Instructions:
 Delivery Instructions: RMACR11096
 Pickup Service(s): Liftgate Pickup, Residential Pickup

NOTES